

Safety in system: Protection for man and machine

Catalogue Automation Technology



Introduction



Heinz and Philip Schmersal,
Managing directors of the Schmersal Group

Turning workplaces into safer places.

Industry finds itself in exciting times - in the age of Industry 4.0, production systems are becoming increasingly flexible and with decentralised intelligence, with man and machine working ever closer. Whatever the change, the safety of employees remains paramount, nothing less is acceptable, and through standards and norms, safety is becoming more and more consistent around the globe.

The Schmersal Group can support you in designing your machinery and plants to ensure maximum safety in accordance with relevant standards and legislation. We offer the world's widest selection of safety components and link them to integrated solutions to satisfy your requirements. We ensure that safety remains an integral component of your processes, thereby helping to maximise system productivity.

Efficient machine safety that complies with relevant standards is a prerequisite for success in international markets. At the same time, the global dimension itself makes machine safety a demanding task. Our international network of tec.nicum experts offers independent advice on all aspects of functional safety, as well as a comprehensive service programme.

When it comes to the safety of machinery and efficient safety technology, you can count on us to be a reliable partner.

Talk to us – we look forward to working with you!

Content

■ Content and Introduction	Page	1
■ Mechanical position detection	Page	10
1. Position switches according to EN 50041/EN 50047	Page	10
2. Position and limit switches	Page	32
3. Position switches – Special variants	Page	78
– Gear switches		
– Rotating spindle limit switches		
– Slack-wire switches		
– Belt alignment switches		
4. Micro switches	Page	86
■ Sensor technology	Page	110
5. Magnetic reed switches	Page	110
Proximity switches		separate catalogue
■ Command and signalling devices	Page	124
6. Pull-wire switches	Page	124
7. Foot switches	Page	132
Further command and signalling devices		separate catalogue
■ Appendix	Page	136
Product index – alphabetical	Page	136
tec.nicum – Services relating to machine safety and industrial safety	Page	138
Addresses	Page	140
Indication legend		Rear cover

Chapter Overview

Mechanical position detection

Mechanical position detection – Special variants



3. Gear switches

Page 78

Sensor technology

Command and signalling devices

Appendix



1. Position switches according to EN 50041/EN 50047
Page 10



2. Position and limit switches
Page 32



3. Rotating spindle limit switches
Page 78



3. Slack-wire switches
Page 78



3. Belt alignment switches
Page 78



4. Micro switches
Page 86



Proximity switches
Separate catalogue



5. Magnetic reed switches
Page 110



Further command and signalling devices
Separate catalogue



6. Pull-wire switches
Page 124



7. Foot switches
Page 132

Product index – alphabetical
Page 136

Addresses
Page 140

Safety in system: Protection for man and machine



Position and limit switches



Belt alignment switches

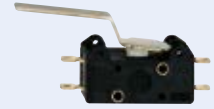

Micro switches

Automation technology: versatile portfolio and customer-specific solutions

For decades, progress in automation technology has ensured ever more efficient production. Digitally automated production started with the introduction of the programmable logic controller (PLC) in the 1970s. Industry 4.0 is continuing this development: with intelligent machines, widespread usage of networks and connection to the Internet, automation technology is reaching a new stage. The resulting positive effects include, for instance, cost and time savings in production as well as an overall increase in competitiveness.

The Schmersal Group has made a significant contribution to this progress over the past few decades, particularly in the area of position acquisition. Schmersal was one of the pioneers during the development of non-contact proximity switches in the 70s.

Today Schmersal offers a broad range of position switches, gear switches, pull-wire switches, foot switches, micro switches and magnetic reed switches... for the automation of work processes in industrial installations.

The continuously further developed series from Schmersal help to increase the efficiency of the manufacturing processes and are suitable for many applications in a very wide range of sectors – from lift switchgear, through automotive technology to heavy industry.

For example the proximity switches are used in, among other areas, robotics and in the automated production lines in the automotive industry. Schmersal also offers a large variety of switchgear for lift and escalator manufacturers for positioning and monitoring the functions of lifts that meet the requirements in directives and standards worldwide.

Besides the standard versions, customised variants for special requirements such as high operating temperatures or sector-specific approvals, e. g. IECEx, are also available.

History

Milestones 1945 – 2016



Schmersal Brazil 1974



Schmersal China 2013



Startup of the new central warehouse in 2013

1945

The brothers Kurt Andreas Schmersal and Ernst Schmersal **form the company** in Wuppertal.

1950s

The **product portfolio** is continuously expanded. Many switchgears are used in safety related applications such as in explosive areas.

1970s

Schmersal is one of the first companies to begin development and production of **electronic proximity switches**.

1974

ACE Schmersal is formed in Boituva, Brazil.

1982

Generational change: Heinz and Stefan Schmersal take over the company from their fathers.

1997

ELAN Schaltelemente GmbH & Co. KG based in Wettenberg is acquired.

1999

The production facility **Schmersal Industrial Switchgear Co. Ltd** (SISS) is formed in Shanghai, China.

2007

Philip Schmersal joins the **third generation of the** Schmersal Group.

2008

In October 2008 the Schmersal Group takes over **Safety Control GmbH** and its affiliate Protec GmbH in Mühlendorf/Inn.

2013

Böhnke + Partner Steuerungssysteme GmbH is acquired.
Schmersal India becomes a production facility.
Startup of the new **European central warehouse** in Wuppertal.

2015

In 2015, the Schmersal Group celebrated its **70th anniversary**.

Schmersal Böhnke+Partner move into a **new production and office building** in Bergisch Gladbach.

2016

The Schmersal Group is establishing its own business area for services under the name **tec.nicum**.

Schmersal worldwide

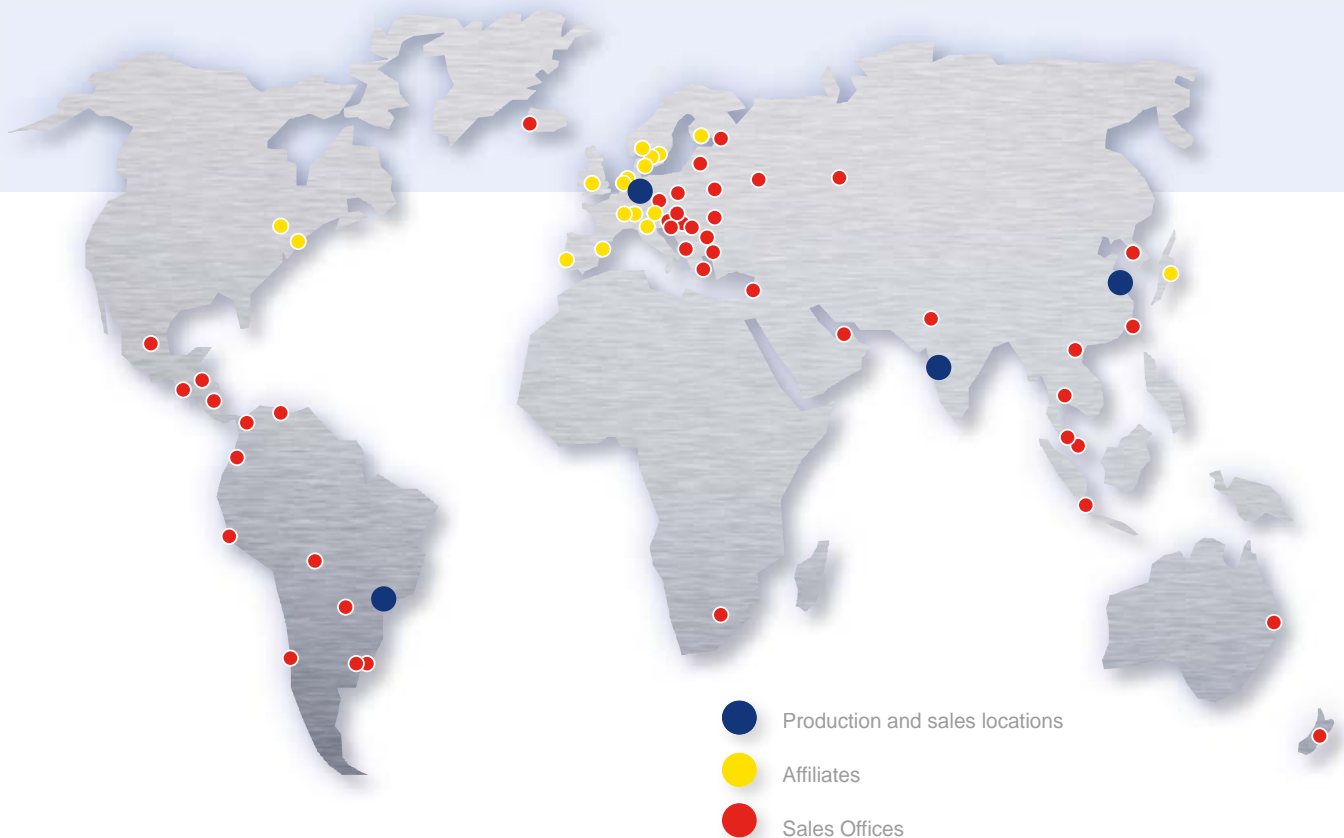

With its own affiliates in around 20 countries and capable sales and service partners in 30 more countries, the Schmersal Group has operations worldwide.

We started quite early with the internationalisation of sales, consultancy and production. This is also one of the reasons that we are a favoured global partner for machinery and plant construction and also an approved partner for many medium sized engineering companies with local presence. Wherever there are machines that work with Schmersal safety switches, the nearest branch or representative is not far away.

Germany, Wuppertal
 Germany, Wettenberg
 Germany, Mühldorf
 Germany, Bergisch Gladbach
 Brazil, Boituva
 China, Shanghai
 India, Pune

Belgium, Aarschot
 Denmark, Ballerup
 Finland, Helsinki
 France, Seyssins
 United Kingdom, Malvern, Worcestershire
 Italy, Borgosatollo
 Japan, Tokyo
 Canada, Brampton
 Netherlands, Harderwijk
 Norway, Oslo
 Austria, Vienna
 Portugal, Póvoa de Sta. Iria
 Sweden, Mölnlycke
 Switzerland, Arni
 Spain, Barcelona
 USA, Tarrytown NY

Argentina, Buenos Aires
 Australia, Brisbane
 Baltic States, Kaunas
 Bolivia, Santa Cruz de la Sierra
 Bulgaria, Ruse City
 Chile, Santiago
 Ecuador, Quito
 Greece, Athens
 Guatemala, Guatemala-City
 Indonesia, Jakarta
 Iceland, Reykjavik
 Israel, Petach Tikva
 Kazakhstan, Ayrar
 Colombia, Medellín
 South Korea, Seoul
 Croatia, Zagreb
 Malaysia, Rawang
 Macedonia, Skopje
 Mexico, Mexico City
 New Zealand, Christchurch
 Pakistan, Islamabad

Paraguay, Minga Guazú
 Peru, Lima
 Poland, Warsaw
 Romania, Sibiu
 Russia, Moscow
 Serbia, Belgrade
 Singapore, Singapore
 Slovenia, Ljubljana
 South Africa, Johannesburg
 Taiwan, Taichung
 Thailand, Bangkok
 Czech Republic, Prague
 Turkey, Istanbul
 Ukraine, Kiev
 Hungary, Győr
 Uruguay, Montevideo
 United Arab Emirates, Sharjah
 Venezuela, Caracas
 Vietnam, Hanoi
 Belarus, Minsk

Schmersal Worldwide

Offices in Germany

Wuppertal



K.A. Schmersal GmbH & Co. KG

- Founded in 1945
- Around 700 employees

Focal points

- Headquarters of the Schmersal Group
- Development and manufacture of switchgears and switching systems for safety, automation and lift engineering
- Accredited test laboratory
- Central research and development
- Logistics centre for European markets

Wettenberg



K.A. Schmersal GmbH & Co. KG

- Founded in 1952 (1997)
- Around 180 employees

Focal points

- Development and manufacture of switchgears for operation and monitoring, safety-related relay modules and controls as well as switchgears for explosion protection

Mühdorf / Inn



Safety Control GmbH

- Founded in 1994 (2008)
- Around 30 employees

Focal points

- Development and manufacture of optical electronic components for safety and automation engineering

Bergisch Gladbach



Böhnke + Partner GmbH Steuerungssysteme

- Founded in 1991 (2013)
- Around 70 employees

Focal points

- Development and manufacture of components, controls and remote diagnostic systems for the lift industry

() = inclusion in the Schmersal Group

Schmersal Worldwide

International Offices

Boituva / Brazil



ACE Schmersal

- Founded in 1974
- Around 400 employees

Focal points

- Manufacture of electromechanical and electronic switchgears
- Customer-specific control systems for the North and South American market

Shanghai / China



Schmersal Industrial Switchgear Co. Ltd

- Founded in 1999
- Around 165 employees

Focal points

- Development and manufacture of switchgears for safety, automation and lift engineering for the Asian market

Pune / India



Schmersal India Private Limited

- Founded in 2013
- Around 60 employees

Focal points

- Development and manufacture of switchgears for safety, automation and lift engineering for the Indian market

1. Position switches according to EN 50041 / EN 50047

Description

System universally deployable series

Recording and monitoring, from extraordinarily compact to very robust.

With these properties, the new position switches are aimed at a wide variety of applications across all disciplines of mechanical engineering and plant manufacturing as well as elevator technology.

The advantages of the new position switch series at a glance:

- Reliable position detection
- Highly versatile
- Robust and reliable
- Can be combined in numerous ways thanks to modular design

Area of application

Type 1 position switches according to ISO 14119 are for determining the position and monitoring of movable components on machines and for protective equipment that can be moved laterally or is rotatable. This allows them to be used in all industrial environments.

The protection classes IP66 an IP67 form the requirements for the use of position switches in adverse ambient conditions.

Design and way of functioning

All position switches are equipped with positive break NC contacts in accordance with IEC 60947-5-1 and are available with snap action and also slow action. In conjunction with an appropriate safety controller, a single position switch can be used up to PL d. Using two position switches PL e can be achieved according to ISO 13849-1.

Flexible solutions

Switching elements with up to three contacts

Switching elements with three contacts ensures a redundant switch-off with additional signalling contact. All switching elements of the diverse contact combinations are equipped with galvanically separated contacts with positive break NC contacts.

Latching function

To save the switching state, versions are available with snap action and an optional latching function where the mounting element must be manually reset to the starting condition.

Modular diversity

The modular design with consistent components across all series reduces the number of different versions, lowers the effort required for storage and increases availability.



Actuator elements and lever

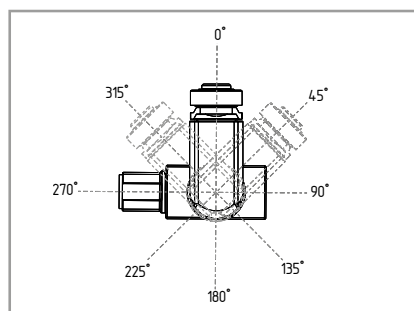

Adjustable actuator elements

All actuating elements can be rotated in 45° steps and can be quickly replaced and implemented due to the simple mounting design.

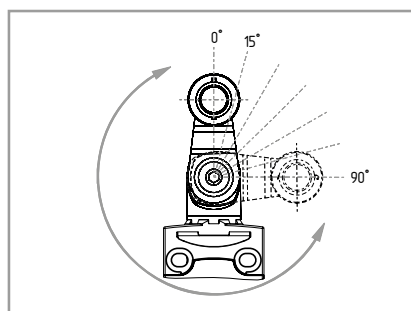

Adjustable lever

Roller lever can be set in 15° steps.

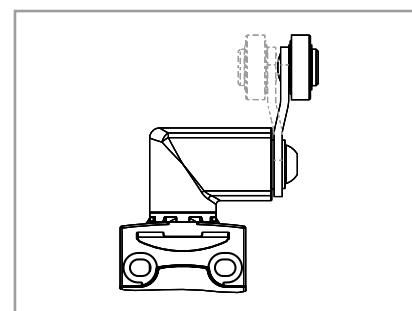

Rotatable lever

For versions with a rotatable roller lever, the lever can be fitted so that the roller is on the inside.

1. Position switches according to EN 50041 / EN 50047

Order information complete device or modular construction kit

All position switches of the PS116, PS2xx and PS3xx series can be obtained either as a complete device or a modular construction kit. The complete device with actuating element S200 serves as a basic switch in the construction kit system. The following ordering example can therefore be transferred to all of the series listed.

Ordering example

Position switch PS116, snap action 1 NO contact / 1 NC contact, roller lever, M12 connector on right



Complete device

Modular selection (construction kit) to be ordered separately



PS116-Z11-STR-H200



Basic switch:
PS116-Z11-STR-S200



Actuator head:



PS-H200

PS-K240

For assembly of the modular selection, the enclosure of the thrust pin included in the basic switch must be removed and replaced by the roller lever PS-H200.



PS-K250

PS-N200

PS-J200

Ordering code

PSxxx-Z11-L200-S200

Switching elements (others on request)

Z11	Snap action 1 NO contact / 1 NC contact
Z12	Snap action 1 NO contact / 2 NC contacts
Z11R	Snap action 1 NO contact / 1 NC contact with latching (not for PS3xx)
T11	Slow action 1 NO contact / 1 NC contact
T12	Slow action 1 NO contact / 2 NC contacts
T03	Slow action 3 NC contacts
T11UE	Slow action 1 NO contact / 1 NC contact with overlapping contacts
T02H	Slow action 2 NC contacts with staggered contacts

Connection

	Cable entry M20, screw connection
ST	Connector plug M12, bottom
STR	Connector plug M12, right
L200	Pre-wired cable bottom, 2 m (PS116 only)
LR200	Pre-wired cable right, 2 m (PS116 only)

Actuator elements (more on request)

PS116 and PS2xx series

S200	Plunger
R200	Roller plunger, roller Ø 9.5 mm
K200	Offset roller lever, roller Ø 12 mm
K210	Offset roller lever, roller Ø 14 mm
K230	Angle roller lever, roller Ø 14 mm
K240	Angle roller lever, roller Ø 22 mm
K250	Angle roller lever, roller Ø 22 mm
H200	Roller lever, roller Ø 16 mm, length 24 mm
N200	Roller lever, roll Ø 20 mm, can be adjusted in 2 mm increments (24 ... 66 mm)
J200	Rod lever with plastic rod Ø 6 mm, length 200 mm

PS3xx series

S300	Plunger
R300	Roller plunger, roller Ø 17.2 mm
K360	Angle roller lever, roller Ø 20 mm
K370	Offset roller lever, roller Ø 20 mm
H300	Offset roller lever, roller Ø 25 mm
N300	Roller lever, roll Ø 20 mm, can be adjusted in 2 mm increments (24 ... 66 mm)
J300	Rod lever, rod Ø 6 mm, length 200 mm

1. Position switches according to EN 50041 / EN 50047

Standardised construction forms, extraordinary features

Folding
latching cover



All plastic versions are fitted with a folding and captive latching cover. The cover can be opened with the aid of a flat-head screwdriver and needs no tools to be closed.

Reduced
assembly times

The 45° rotated connection terminals of all switch elements reduce the assembly time considerably.



Actuating element replace and turn

All actuating elements can be rotated in 45° steps and can be quickly replaced and implemented due to the simple mounting design. This means that adaptation to the prescribed actuating direction is possible at any time.

PS116



1. Release locking plate
(flat-head screwdriver or
accessory tool ACC-PS116-1)

2. Remove or turn existing
actuating element

3. Position of new
actuating element

4. Secure locking plate

The symmetrical layout of the enclosure means that it can be used for left-hand and right-hand versions of the same switch. This applies to both the cable and the connector design.

PS2xx / PS3xx

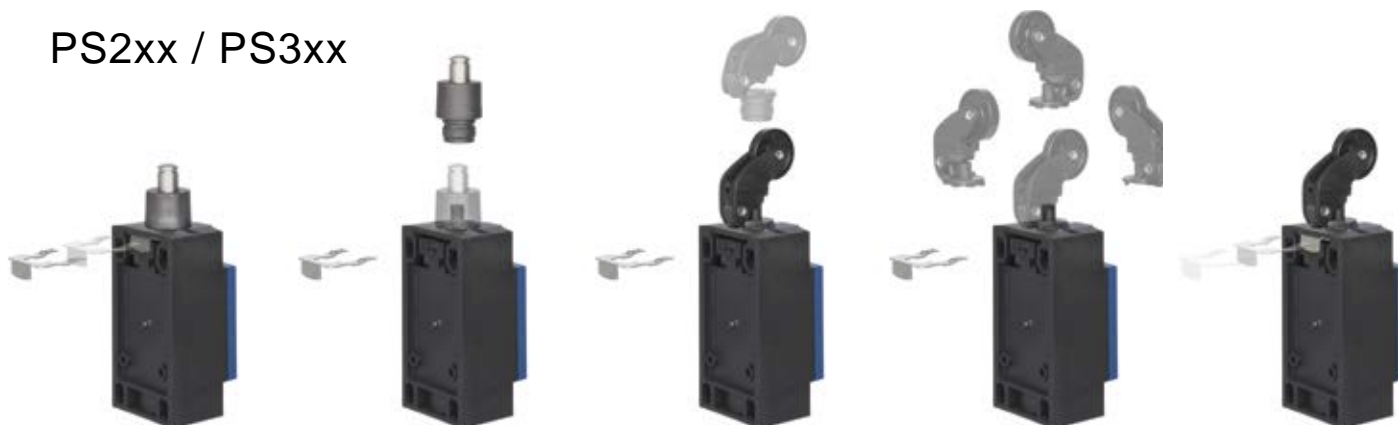

1. Release locking plate
(flat-head screwdriver)

2. Remove or turn existing
actuating element

3. Position of new
actuating element

4. Secure locking plate

1. Position switches according to EN 50041 / EN 50047

Overview of the series



■ PS116



■ PS215



■ PS216

Key Features

- | | | |
|---|---|--|
| <ul style="list-style-type: none"> • Symmetrical casing • Compact design • Fitted (cable / M12 connector) • Complete device or modular construction kit • Design to EN 50047 | <ul style="list-style-type: none"> • Simplified connection (connection terminals rotated by 45°) • Robust design • Complete device or modular construction kit • Design to EN 50047 | <ul style="list-style-type: none"> • Simplified connection (connection terminals rotated by 45°) • Folding latching cover • Complete device or modular construction kit • Design to EN 50047 |
|---|---|--|

Technical features

Electrical characteristics			
Switching system	Snap-/slow action	Snap-/slow action	Snap-/slow action
Latching variant	■	■	■
Max. number of contacts	3	3	3
Max. switching capacity U/I	230 VAC / 3 A; 24 VDC / 1.5 A	230 VAC / 3 A; 24 VDC / 3 A	230 VAC / 3 A; 24 VDC / 3 A
Mechanical data			
Housing material	Metal / thermoplastic enclosure	Metal enclosure, painted	Thermoplastic enclosure
Connection	Cable 4/6 pole M12 connector 4/6 pole	1 x M20 M12 connector 5/8 pole	1 x M20 M12 connector 4/8 pole
Cable section ³⁾	4/6 x 0.5 mm ²	max. 1.5 mm ² (incl. conductor ferrules)	max. 1.5 mm ² (incl. conductor ferrules)
Dimensions (W x H x D)	31 x 52 x 16.6 mm	31 x 66 x 33 mm	31 x 66 x 33 mm
Ambient conditions			
Ambient temperature	-30 °C ... +80 °C	-30 °C ... +80 °C	-30 °C ... +80 °C
Protection class	IP66, IP67	IP66, IP67	IP66, IP67
Actuator heads	see page 18	see page 18	see page 18

Safety classification

Standards	ISO 13849-1	ISO 13849-1	ISO 13849-1
B_{10D} NC contact	20,000,000	20,000,000	20,000,000
Certificates			



To get detailed information about the products and certificates, visit www.schmersal.net.



■ PS226



■ PS315



■ PS316

- | | | |
|--|---|--|
| <ul style="list-style-type: none"> • Simplified connection (connection terminals rotated by 45°) • Folding latching cover • Complete device or modular construction kit • Design to EN 50047 | <ul style="list-style-type: none"> • Simplified connection (connection terminals rotated by 45°) • Robust design • Complete device or modular construction kit • Design to EN 50041 | <ul style="list-style-type: none"> • Simplified connection (connection terminals rotated by 45°) • Folding latching cover • Complete device or modular construction kit • Design to EN 50041 |
|--|---|--|

Snap-/slow action	Snap-/slow action	Snap-/slow action
■	–	–
3	3	3
230 VAC / 3 A; 24 VDC / 3 A	230 VAC / 3 A; 24 VDC / 3 A	230 VAC / 3 A; 24 VDC / 3 A
Thermoplastic enclosure	Metal enclosure, painted	Thermoplastic enclosure
2 x M20 M12 connector 4/8 pole	1 x M20 M12 connector 5/8 pole	1 x M20 M12 connector 4/8 pole
max. 1.5 mm ² (incl. conductor ferrules)	max. 1.5 mm ² (incl. conductor ferrules)	max. 1,5 mm ² (incl. conductor ferrules)
31 x 59.2 x 33 mm	40 x 77.7 x 37.2 mm	40 x 77.7 x 37.2 mm
–30 °C ... +80 °C	–30 °C ... +80 °C	–30 °C ... +80 °C
IP66, IP67	IP66, IP67	IP66, IP67
see page 18	see page 22	see page 22

ISO 13849-1 20,000,000	ISO 13849-1 20,000,000	ISO 13849-1 20,000,000

1. Position switches according to EN 50041 / EN 50047 PS116 / PS2xx – Actuator heads



Plunger S200

Roller plunger R200

Actuator heads

Actuator description	Thermoplastic plunger Actuator type B according to EN 50047	Thermoplastic roller plunger Actuator type C according to EN 50047
Positive break force	> 40 N	> 40 N
Actuating speed	min. 10 mm/min, max. 0.5 m/s	min. 10 mm/min, max. 0.5 m/s
Snap action		
Slow action	min. 60 mm/min, max. 0.5 m/s	min. 60 mm/min, max. 0.5 m/s
Positioning the lever	-	-

Ordering data modular construction kit

Product type description	PS-S200	PS-R200
Material number	103010968	103010967

Switch travel diagrams

Snap action	Per NO contact / per NC contact		
Slow action	Per NO contact / per NC contact		
	1 NO / 1 NC with overlapping		
	2 NC with staggered contacts		

Contact closed

Contact open

Positive break travel / angle



Offset roller lever K200



Offset roller lever K210



Angle roller lever K230

Thermoplastic offset roller lever
Actuator type E according to EN 50047

> 40 N

min. 10 mm/min,
max. 1 m/s

min. 60 mm/min,
max. 1 m/s

-

Thermoplastic offset roller lever

> 40 N

min. 10 mm/min,
max. 1 m/s

min. 60 mm/min,
max. 1 m/s

-

Thermoplastic angle roller lever

> 40 N

min. 10 mm/min,
max. 1 m/s

min. 60 mm/min,
max. 1 m/s

-

PS-K200
103010961

PS-K210
103010962

PS-K230
103010963

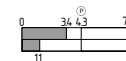
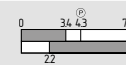
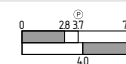
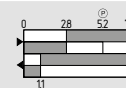
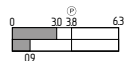
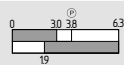
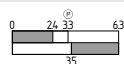
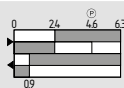
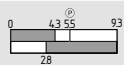
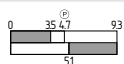
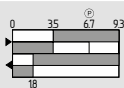

1. Position switches according to EN 50041 / EN 50047 PS116 / PS2xx – Actuator heads

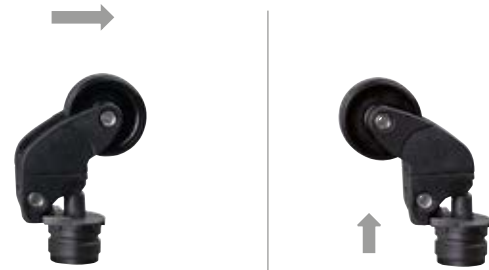

Angle roller lever K240 **Angle roller lever K250**

Actuator heads

Actuator description	Thermoplastic angle roller lever	Thermoplastic angle roller lever
Positive break force	> 40 N	> 40 N
Actuating speed	min. 10 mm/min,	min. 10 mm/min,
Snap action	max. 1 m/s	max. 1 m/s
Slow action	min. 60 mm/min,	min. 60 mm/min,
	max. 1 m/s	max. 1 m/s
Positioning the lever	-	-

Ordering data modular construction kit

Product type description	PS-K240	PS-K250
Material number	103010964	103010965

Switch travel diagrams

Snap action	Per NO contact / per NC contact		
Slow action	Per NO contact / per NC contact		
	1 NO / 1 NC with overlapping		
	2 NC with staggered contacts		

Contact closed

Contact open

Positive break travel / angle



Roller lever H200



Roller lever N200



Roller lever J200

Metal lever with plastic roller
Actuator type A according to EN 50047

> 40 N

min. 10 mm/min,
max. 1 m/s

min 60 mm/min,
max. 1 m/s

adjustable in 15° steps

Length adjustable metal lever
with plastic roller
adjustable in 2 mm increments

> 40 N

min. 10 mm/min,
max. 1 m/s

min. 60 mm/min,
max. 1 m/s

adjustable in 15° steps

Plastic rod, 200 mm
Can only be used for positioning tasks

> 40 N

min. 10 mm/min,
max. 1 m/s

min 60 mm/min,
max. 1 m/s

adjustable in 15° steps

PS-H200
103010948

PS-N200
103010966

PS-J200
103010951

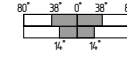
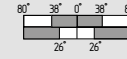
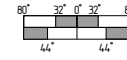
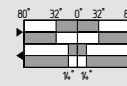
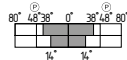
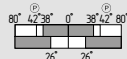
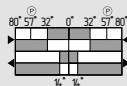
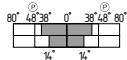
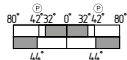
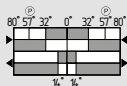

1. Position switches according to EN 50041 / EN 50047

PS3xx – Actuator heads



Plunger S300



Roller plunger R300

Actuator heads

Actuator description	Thermoplastic plunger Actuator type B according to EN 50041	Thermoplastic roller plunger Actuator type C according to EN 50041
Positive break force	> 50 N	> 50 N
Actuating speed	min. 10 mm/min, max. 0.5 m/s	min. 10 mm/min, max. 0.5 m/s
Snap action		
Slow action	min. 60 mm/min, max. 0.5 m/s	min. 60 mm/min, max. 0.5 m/s
Positioning the lever	-	-

Ordering data modular construction kit

Product type description	PS-S300	PS-R300
Material number	103015397	103015398

Switch travel diagrams

Snap action	Per NO contact / per NC contact		
Slow action	Per NO contact / per NC contact		
	1 NO / 1 NC with overlapping		
	2 NC with staggered contacts		

■ Contact closed

□ Contact open

Ⓟ Positive break travel / angle



Angle roller lever K360



Offset roller lever K370



Roller lever H300

Thermoplastic angle roller lever	Thermoplastic offset roller lever	Metal lever with plastic roller Actuator type A according to EN 50041
> 50 N min. 10 mm/min, max. 1 m/s min. 60 mm/min, max. 1 m/s -	> 50 N min. 10 mm/min, max. 1 m/s min. 60 mm/min, max. 1 m/s -	> 50 N min. 10 mm/min, max. 1 m/s min. 60 mm/min, max. 1 m/s adjustable in 15° steps
PS-K360 103015399	PS-K370 103015400	PS-H300 103015401

1. Position switches according to EN 50041 / EN 50047

PS3xx – Actuator heads



Roller lever N300

Roller lever J300

Actuator heads

Actuator description	Roller lever N300	Roller lever J300
Actuator description	Length adjustable metal lever with plastic roller adjustable in 2 mm increments	Plastic rod, 200 mm Can only be used for positioning tasks Actuator type A according to EN 50041
Positive break force	> 50 N	-
Actuating speed	min. 10 mm/min, max. 1 m/s	min. 10 mm/min, max. 1 m/s
Snap action		
Slow action	min. 60 mm/min, max. 1 m/s	min. 60 mm/min, max. 1 m/s
Positioning the lever	adjustable in 15° steps	adjustable in 15° steps

Ordering data modular construction kit

Product type description	PS-N300	PS-J300
Material number	103015402	103015403

Switch travel diagrams

Actuator	Switch action	Per NO contact / per NC contact	Diagram 1	Diagram 2
Roller lever N300	Snap action	Per NO contact / per NC contact		
	Slow action	Per NO contact / per NC contact		
Roller lever J300	Snap action	Per NO contact / per NC contact		
	Slow action	Per NO contact / per NC contact		
Roller lever N300	1 NO / 1 NC with overlapping			
	2 NC with staggered contacts			
Roller lever J300	1 NO / 1 NC with overlapping			
	2 NC with staggered contacts			

Contact closed

Contact open

Positive break travel / angle

tec.nicum

Your partner for machine safety and workplace protection

tec.nicum is the new service division of the Schmersal Group. It offers machine manufacturers, machine operators and distributors competent advice with product and manufacturer neutrality.

tec.nicum supports its clients in the reliable design of machines and workplaces. The tec.nicum team drafts and realises safety solutions across all lifecycle stages of the machine.

The new range of services:



tec.nicum academy
Seminars and training



tec.nicum consulting
Consultancy services



tec.nicum engineering
Design, planning and
PLC programming



tec.nicum integration
Execution and installation



For detailed information, check out
www.tecnicum.com

1. Position switches according to EN 50041 / EN 50047

PS116 – Preferred types and ordering details



Position switch with actuating element	Connection	Switching system	NO contacts	NC contacts	Type designation	Material number
S200 Basic switch	Connector plug	Snap action	1	1	PS116-Z11-ST-S200	103006651
			1	2	PS116-Z12-ST-S200	103006662
		Slow action	1	1	PS116-T11-ST-S200	103006652
	Connecting cable	Snap action	1	1	PS116-Z11-L200-S200	103006633
			1	2	PS116-Z12-L200-S200	103006647
			1	1	PS116-Z11R-L200-S200	103009907
		Snap action with latch	0	2	PS116-Z02R-L200-S200	103012043
			1	1	PS116-T11-L200-S200	103006634
			1	1	PS116-T11-L200-S200	103006634
R200	Connector plug	Snap action	1	1	PS116-Z11-ST-R200	103006653
			0	2	PS116-Z02-ST-R200	103008391
			1	2	PS116-Z12-ST-R200	103006663
		Snap action with latch	1	2	PS116-Z12R-ST-R200	103009897
			1	1	PS116-T11-ST-R200	103006654
			2	1	PS116-T21-ST-R200	103009215
	Connecting cable	Snap action	1	1	PS116-Z11-L200-R200	103006635
			1	1	PS116-T11-L200-R200	103006636
			1	2	PS116-T12-L200-R200	103006648
		Slow action	1	1	PS116-Z11-L200-K200	103006655
			1	2	PS116-Z12-L200-K200	103006664
			1	1	PS116-Z11-L200-K200	103006637
K210	Connector plug	Snap action	1	1	PS116-Z11-ST-K210	103006656
			1	2	PS116-Z12-ST-K210	103009491
		Slow action	1	1	PS116-T11-ST-K210	103006657
			2	1	PS116-T21-ST-K210	103013834
	Connecting cable	Snap action	1	1	PS116-Z11-L200-K210	103006638
			1	2	PS116-Z12R-L200-K210	103009906
		Slow action	1	1	PS116-T11-L200-K210	103006639
			1	1	PS116-Z11-L200-K230	103006658
			0	2	PS116-T02-ST-K230	103014690
K230	Connector plug	Snap action	1	1	PS116-Z11-L200-K230	103006640
			0	2	PS116-Z02-L200-K230	103011608
	Connecting cable	Snap action	1	2	PS116-Z12-ST-K240	103006665
			1	1	PS116-Z11-L200-K240	103006641
K240	Connector plug	Snap action	1	2	PS116-Z12-ST-K250	103006666
	Connector plug		1	2	PS116-T12-ST-K250	103006667
K250	Connecting cable	Snap action	1	1	PS116-Z11-L200-K250	103006642
			1	1	PS116-T11-L200-K250	103006643
	Slow action	1	1	PS116-T11-L200-K250	103006643	
		1	2	PS116-T12-L200-K250	103015281	

To see a wide range of other types, visit www.schmersal.net.

1. Position switches according to EN 50041 / EN 50047

PS116 – Preferred types and ordering details



Position switch with actuating element	Connection	Switching system	NO contacts	NC contacts	Type designation	Material number
H200	Connector plug	Snap action	1	1	PS116-Z11-ST-H200	103006659
			1	2	PS116-Z12-ST-H200	103009490
		Slow action	1	1	PS116-T11-ST-H200	103006660
			1	2	PS116-T12-ST-H200	103006668
			0	3	PS116-T03-ST-H200	103012315
	Connecting cable	Snap action	1	1	PS116-Z11-L200-H200	103006644
		Slow action	1	1	PS116-T11-L200-H200	103006645
			1	2	PS116-T12-L200-H200	103006649
N200	Connector plug	Snap action	1	1	PS116-Z11-ST-N200	103006661
			1	2	PS116-Z12-ST-N200	103010921
		Slow action	1	1	PS116-T11-ST-N200	103011367
			2	0	PS116-T20-ST-N200	103010065
			1	2	PS116-T12-ST-N200	103011553
			2	1	PS116-T21-ST-N200	103010067
	Connecting cable	Snap action	1	1	PS116-Z11-L200-N200	103006646
			1	2	PS116-Z12-L200-N200	103008748
		Slow action	1	2	PS116-T12-L200-N200	103006650
J200	Connector plug	Slow action with staggered contacts	0	2	PS116-T02H-ST-J200	103014413

1. Position switches according to EN 50041 / EN 50047

PS2xx – Preferred types and ordering details



Position switch with actuating element	Switching system	NO contacts	NC contacts	Type designation	Material number	
S200 Basic switch	PS215 Metal	Snap action	1	1	PS215-Z11-S200	103014952
			0	2	PS215-Z02-S200	103014953
			1	2	PS215-Z12-S200	103014954
		Slow action	1	1	PS215-T11-S200	103014977
			0	2	PS215-T02-S200	103014978
			1	2	PS215-T12-S200	103014979
	PS216 Thermoplastic	Snap action	1	1	PS216-Z11-S200	103013713
			0	2	PS216-Z02-S200	103015001
			1	2	PS216-Z12-S200	103015002
		Slow action	1	1	PS216-T11-S200	103015022
			0	2	PS216-T02-S200	103015023
			1	2	PS216-T12-S200	103015024
	PS226 Thermoplastic	Snap action	1	1	PS226-Z11-S200	103015048
			0	2	PS226-Z02-S200	103015049
			1	2	PS226-Z12-S200	103015050
		Slow action	1	1	PS226-T11-S200	103015073
			0	2	PS226-T02-S200	103015074
			1	2	PS226-T12-S200	103015075
R200	PS215 Metal	Snap action	1	1	PS215-Z11-R200	103014955
		Slow action	1	1	PS215-T11-R200	103014981
	PS216 Thermoplastic	Snap action	1	1	PS216-Z11-R200	103015003
			0	2	PS216-Z02-R200	103015004
			1	2	PS216-Z12-R200	103015005
		Slow action	1	1	PS216-T11-R200	103015028
			0	2	PS216-T02-R200	103015029
			1	2	PS216-T12-R200	103015030
	PS226 Thermoplastic	Snap action	1	1	PS226-Z11-R200	103015051
		Slow action	1	1	PS226-T11-R200	103015076

To see a wide range of other types, visit www.schmersal.net.

1. Position switches according to EN 50041 / EN 50047

PS2xx – Preferred types and ordering details



Position switch with actuating element		Switching system	NO contacts	NC contacts	Type designation	Material number
K200	PS216 Thermoplastic	Snap action	1	1	PS216-Z11-K200	103015006
		Slow action	1	1	PS216-T11-K200	103015031
K210	PS215 Metal	Snap action	1	1	PS215-Z11-K210	103014960
		Slow action	1	1	PS215-T11-K210	103014988
	PS216 Thermoplastic	Snap action	1	1	PS216-Z11-K210	103015008
		Slow action	1	1	PS216-T11-K210	103015033
K230	PS215 Metal	Snap action	1	1	PS215-Z11-K230	103014963
		Slow action	1	1	PS215-T11-K230	103014988
	PS216 Thermoplastic	Snap action	1	1	PS216-Z11-K230	103015010
		Slow action	1	1	PS216-T11-K230	103015035
K240	PS215 Metal	Slow action	1	1	PS215-T11-K240	103014991
		Snap action	1	1	PS216-Z11-K240	103015013
	PS216 Thermoplastic	Slow action	1	1	PS216-T11-K240	103015038
		Snap action	1	1	PS226-Z11-K240	103015061
K250	PS216 Thermoplastic	Snap action	1	1	PS216-Z11-K250	103015015
		Slow action	1	1	PS216-T11-K250	103015040
H200	PS215 Metal	Slow action	1	1	PS215-T11-H200	103014995
			1	2	PS216-Z11-H200	103013857
	PS216 Thermoplastic	Snap action	1	2	PS216-Z12-H200	103015017
			1	1	PS216-T11-H200	103015042
			1	2	PS216-T12-H200	103015043
N200	PS215 Metal	Snap action	1	1	PS215-Z11-N200	103014972
		Slow action	1	1	PS215-T11-N200	103014997
	PS216 Thermoplastic	Snap action	1	1	PS216-Z11-N200	103015018
			1	2	PS216-Z12-N200	103015019
		Slow action	1	1	PS216-T11-N200	103015044
			1	2	PS216-T12-N200	103015045
J200	PS215 Metal	Snap action	1	1	PS215-Z11-J200	103014974
	PS216 Thermoplastic	Snap action	1	1	PS216-Z11-J200	103015020

1. Position switches according to EN 50041 / EN 50047

PS3xx – Preferred types and ordering details



Position switch with actuating element	Switching system	NO contacts	NC contacts	Type designation	Material number		
S200 Basic switch	PS315 Metal	Snap action	1	1	PS315-Z11-S200	103015406	
			0	2	PS315-Z02-S200	103015407	
			1	2	PS315-Z12-S200	103015408	
		Slow action	1	1	PS315-T11-S200	103015412	
			0	2	PS315-T02-S200	103015414	
			1	2	PS315-T12-S200	103015415	
	PS316 Thermoplastic	Snap action	1	1	PS316-Z11-S200	103015409	
			0	2	PS316-Z02-S200	103015410	
			1	2	PS316-Z12-S200	103015411	
		Slow action	1	1	PS316-T11-S200	103015417	
			0	2	PS316-T02-S200	103015418	
			1	2	PS316-T12-S200	103015419	
	S300	PS315 Metal	Snap action	1	1	PS315-Z11-S300	103015096
				0	2	PS315-Z02-S300	103015097
				1	2	PS315-Z12-S300	103015098
Slow action			1	1	PS315-T11-S300	103015112	
			0	2	PS315-T02-S300	103015113	
			1	2	PS315-T12-S300	103015114	
PS316 Thermoplastic		Snap action	1	1	PS316-Z11-S300	103015129	
			0	2	PS316-Z02-S300	103015130	
			1	2	PS316-Z12-S300	103015131	
		Slow action	1	1	PS316-T11-S300	103015146	
			0	2	PS316-T02-S300	103015147	
			1	2	PS316-T12-S300	103015148	
R300		PS315 Metal	Snap action	1	1	PS315-Z11-R300	103015099
				0	2	PS315-Z02-R300	103015100
			Slow action	1	1	PS315-T11-R300	103015116
	0	2		PS315-T02-R300	103015117		
	PS316 Thermoplastic	Snap action	1	1	PS316-Z11-R300	103015132	
			0	2	PS316-Z02-R300	103015133	
		Slow action	1	1	PS316-T11-R300	103015152	
			0	2	PS316-T02-R300	103015153	

To see a wide range of other types, visit www.schmersal.net.

1. Position switches according to EN 50041 / EN 50047

PS3xx – Preferred types and ordering details



Position switch with actuating element		Switching system	NO contacts	NC contacts	Type designation	Material number
K360	PS315 Metal	Snap action	1	1	PS315-Z11-K360	103015102
		Slow action	1	1	PS315-T11-K360	103015119
	PS316 Thermoplastic	Snap action	1	1	PS316-Z11-K360	103015135
		Slow action	1	1	PS316-T11-K360	103015155
K370	PS315 Metal	Snap action	1	1	PS315-Z11-K370	103015104
		Slow action	1	1	PS315-T11-K370	103015121
	PS316 Thermoplastic	Snap action	1	1	PS316-Z11-K370	103015137
		Slow action	1	1	PS316-T11-K370	103015157
H300	PS315 Metal	Snap action	1	1	PS315-Z11-H300	103015106
		Slow action	1	1	PS315-T11-H300	103015123
	PS316 Thermoplastic	Snap action	1	1	PS316-Z11-H300	103015139
		Slow action	1	1	PS316-T11-H300	103015159
			1	2	PS316-T12-H300	103015160
N300	PS315 Metal	Snap action	1	1	PS315-Z11-N300	103015108
		Slow action	1	1	PS315-T11-N300	103015125
	PS316 Thermoplastic	Snap action	1	1	PS316-Z11-N300	103015141
		Slow action	1	1	PS316-T11-N300	103015161
			1	2	PS316-T12-N300	103015162
J300	PS315 Metal	Snap action	1	1	PS315-Z11-J300	103015110
		Slow action	1	1	PS315-T11-J300	103015127
	PS316 Thermoplastic	Snap action	1	1	PS316-Z11-J300	103015143
		Slow action	1	1	PS316-T11-J300	103015163

2. Position and limit switches

Description

Area of application

Position and limit switches are used to detect the position and monitoring of moving parts in machinery and plants. The various series are suitable for applications including steel processing, the transport and handling of bulk materials, as well as in other fixed plants and vehicles.

Design and operating principle

Various series are available, all of which are equipped with a robust metal enclosure and all of which are suitable for position detection under extreme ambient conditions. These include types with extended temperature ranges, covering applications at high temperature in steel works or foundries, as well as applications at low temperature in cold store warehouses. The enclosures, coated in a dual-component finish, protect the switches from oil, grease, salt and acids in diluted concentrations.

The ATEC/IECEX-certified types allow for use in potentially explosive environments. Corresponding solutions exist for zones 1 and 21.

In the individual series there are, in addition to the various standard actuators, also individual actuating elements for different applications. With the switching elements, the user has the choice of a number of different variants with up to six contacts.

Position and limit switches have been part of the core programme of the Schmersal Group for decades. The variety of designs and product ranges is correspondingly large.



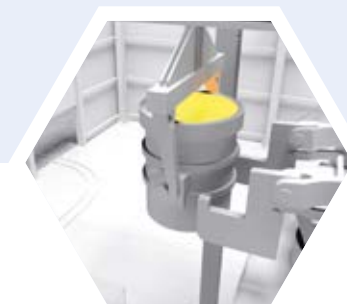

Overview

Position and limit switches		you can find from
Standard switches	M 330	Page 38
Series S0	T/M 015	Page 48
	T 016	
	T/M 017	
Series S1	T 422	Page 56
	T/M 441	
	T 454	
	T/M 461	
Series U	U 432	Page 62
	U 434	
Series S3	T/M 035	Page 68
	T/M 250	
Series S2	T/M 064	Page 72
	T/M 471	
	T 130/136	

2. Position and limit switches

Overview of the series



■ M 330



■ T/M 015



■ T 016

Key Features

- **Standard switch**
- 2 contacts
- Metal enclosure
- Design EN 50041

- **Series S0**
- 2 contacts
- Metal enclosure

- **Series S0**
- 3 contacts
- Metal enclosure

Technical features

Electrical characteristics			
Switching principle	Snap action	Slow action or snap action, positive break NC contact	Slow action, positive break NC contact
Max. switching capacity U/I			
- Snap action	230 VAC / 2.5 A	400 VAC / 2.5 A	-
- Slow action	-	400 VAC / 4 A	400 VAC / 4 A
Mechanical data			
Housing material	Aluminium die-cast, paint finish	Aluminium die-cast, paint finish	Aluminium die-cast, paint finish
Cable entry	1 x M20	3 x M20	3 x M20
Connection	Screw terminals	Screw terminals	Screw terminals
Cable section ¹⁾	max. 2.5 mm ²	max. 2.5 mm ²	max. 2.5 mm ²
Dimensions (W x H x D)	40 x 76 x 40 mm	67 x 75 x 43 mm	67 x 105 x 43 mm
Ambient conditions			
Ambient temperature	-30 °C ... +90 °C up to -40 °C (-1172) up to +160 °C (-1366)	-30 °C ... +90 °C	-30 °C ... +90 °C
Protection class	IP65	IP65	IP65
Actuator heads	see page 38	see page 48	see page 48

Safety classification

Standards	IEC 60947-5-1	IEC 60947-5-1	IEC 60947-5-1
B_{10D} NC contact	20,000,000	2,000,000	2,000,000
Certificates			

Other versions

ATEX / IECEx	Zone 22	-	-
with gold-plated contacts	-	-	-
With blow-out magnets to switch high DC currents	-	■	■



To get detailed information about the products and certificates, visit www.schmersal.net.



■ T/M 017



■ T 422



■ T/M 441



■ T 454



■ T/M 461

- **Series S0**
- 4 contacts
- Metal enclosure

- **Series S1**
- 1 contact
- Metal enclosure

- **Series S1**
- 2 contacts
- Metal enclosure

- **Series S1**
- 2 or 4 contacts
- Metal enclosure
- Exterior parts made of stainless steel

- **Series S1**
- 3 or 4 contacts
- Metal enclosure

Slow action or snap action, positive break NC contact	Slow action, positive break NC contact	Slow action or snap action, positive break NC contact	Slow action, positive break NC contact	Slow action or snap action, positive break NC contact
400 VAC / 2.5 A 400 VAC / 4 A	- 400 VAC / 4 A	230 VAC / 4 A 400 VAC / 4 A	230 VAC / 4 A 230 VAC / 4 A	230 VAC / 4 A 400 VAC / 4 A
Aluminium die-cast, paint finish	Grey cast iron, galvanised and painted	Grey cast iron, galvanised and painted	Grey cast iron, galvanised and painted	Grey cast iron, galvanised and painted
3 x M20	2 x M20	2 x M20	2 x M20	2 x M20
Screw terminals max. 2.5 mm ²	Screw terminals max. 2.5 mm ²	Screw terminals max. 2.5 mm ²	Screw terminals max. 2.5 mm ²	Screw terminals max. 2.5 mm ²
67 x 130 x 43 mm	75 x 71 x 63 mm	75 x 99 x 63 mm	83 x 127 x 64 mm	83 x 155 x 64 mm
-30 °C ... +90 °C	-30 °C ... +90 °C -40 °C ... +200 °C	-30 °C ... +90 °C -40 °C ... +200 °C	-40 °C ... +70 °C	-30 °C ... +90 °C -40 °C ... +200 °C
IP65 see page 48	IP65 see page 56	IP65 see page 56	IP66, IP67 see page 56	IP65 see page 56

IEC 60947-5-1 2,000,000	IEC 60947-5-1 2,000,000	IEC 60947-5-1 2,000,000	IEC 60947-5-1 2,000,000	IEC 60947-5-1 2,000,000

-	-	Zone 21, 22	Zone 1, 21	-
-	0.3 µm	0.3 µm	0.3 µm	0.3 µm
■	-	-	-	-

¹⁾ Including conductor ferrules

2. Position and limit switches

Overview of the series



■ U 432

■ U 434

■ T/M 035

Key Features

- | | | |
|--|--|---|
| <ul style="list-style-type: none"> • Series U • 2 contacts • Metal enclosure • Switching points and contact type adjustable | <ul style="list-style-type: none"> • Series U • 4 contacts • Metal enclosure • Switching points and contact type adjustable | <ul style="list-style-type: none"> • Series S3 • 2 contacts • Metal enclosure • Ball-bearing mounted switching shaft |
|--|--|---|

Technical features

Electrical characteristics			
Switching principle	Slow action	Slow action	Slow action or snap action, positive break NC contact
Max. switching capacity U/I			
- Snap action	-	-	400 VAC / 2.5 A
- Slow action	400 VAC / 6 A	400 VAC / 6 A	400 VAC / 4 A
Mechanical data			
Housing material	Aluminium die-cast, paint finish	Aluminium die-cast, paint finish	Grey cast iron, galvanised and painted
Cable entry	3 x M20	3 x M20	3 x M20
Connection	Screw terminals	Screw terminals	Screw terminals
Cable section ¹⁾	max. 2.5 mm ²	max. 2.5 mm ²	max. 2.5 mm ²
Dimensions (W x H x D)	62 x 80 x 50 mm	62 x 127 x 50 mm	58 x 142 x 61.5 mm
Ambient conditions			
Ambient temperature - Tropical and temperature resistant	-20 °C ... +60 °C up to -30 °C (-1272)	-20 °C ... +60 °C up to -30 °C (-1272)	-30 °C ... +90 °C
Protection class	IP65	IP65	IP67
Actuator heads	see page 62	see page 62	see page 68

Safety classification

Standards	IEC 60947-5-1	IEC 60947-5-1	IEC 60947-5-1
B_{10D} NC contact	2,000,000	2,000,000	2,000,000
Certificates			

Other versions

ATEX / IECEx	-	-	-
with gold-plated contacts	-	-	-
With blow-out magnets to switch high DC currents	-	-	■



To get detailed information about the products and certificates, visit www.schmersal.net.



■ T/M 250



■ T/M 064



■ T/M 471



■ T 130/136

- **Series S3**
- 2 or 4 contacts
- Metal enclosure
- Switching mechanism can be set

- **Series S2**
- 3 or 4 contacts
- Metal enclosure
- Switching mechanism can be set for switching to right, left or in both directions

- **Series S2**
- 4 or 6 contacts
- Metal enclosure
- Switching mechanism can be set for switching to right, left or in both directions

- **Series S2**
- T 130: 6 contacts;
T 136: 4 contacts
- Metal enclosure

Slow action or snap action, positive break NC contact	Slow action or snap action, positive break NC contact	Slow action or snap action, positive break NC contact	Slow action, positive break NC contact
230 VAC / 2.5 A 400 VAC / 4 A	400 VAC / 25 A 400 VAC / 25 A	400 VAC / 25 A 400 VAC / 25 A	- T 130: 400 VAC / 25 A T 136: 400 VAC / 25 A
Grey cast iron, galvanised and painted 2 x M25	Grey cast iron, galvanised and painted 2 x M25	Grey cast iron, galvanised and painted 3 x M25	Grey cast iron, galvanised and painted 4 x M25
Screw terminals max. 2.5 mm ²	Screw terminals max. 4 mm ²	Screw terminals max. 4 mm ²	Screw terminals max. 4 mm ²
103 x 180 x 125 mm	149 x 156 x 111 mm	130 x 194 x 150 mm	T 130: 135 x 154 x 120; T 136: 154 x 154 x 120
-30 °C ... +90 °C -40 °C ... +200 °C	-30 °C ... +90 °C	-30 °C ... +90 °C	-30 °C ... +90 °C
IP67 see page 69	IP65 see page 72	IP65 see page 72	IP65 see page 72

IEC 60947-5-1 2,000,000	IEC 60947-5-1 2,000,000	IEC 60947-5-1 2,000,000	IEC 60947-5-1 1,000,000

Zone 21, 22	Zone 21, 22	-	-
-	-	-	-
■	-	-	-

¹⁾ Including conductor ferrules

2. Position and limit switches

Series M330 – Actuating elements



Plunger S



Telescopic plunger 2 S

Actuator heads

Actuator description	Plunger to DIN EN 50041	Sleeve for protection against the ingress of dirt
Head can be turned 4 x 90°	-	-
Actuating force	17.5 N	45 N
Actuating torque	-	-

Switch travel diagrams

Snap action 1 NO / 1 NC

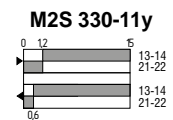
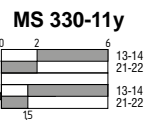



Roller plunger R



Offset roller lever K



Angle roller lever 3K

to DIN EN 50041
Plastic roller
Actuation head can be rotated by 90°
with metal roller available on request

-
17.5 N

Plastic roller
Actuator head can be repositioned
in steps 4 x 90°
with metal roller available on request

-
19 N

Plastic roller
Actuation parallel to axis of switch
from below
Actuator head can be repositioned
in steps 4 x 90°
with metal roller available on request

-
16 N

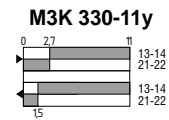
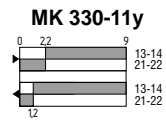
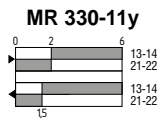

2. Position and limit switches

Series M330 – Actuating elements



Side plunger 3S

Side roller plunger 3R

Actuator heads

Actuator description	Side plunger 3S	Side roller plunger 3R
Actuator description	Sleeve for protection against the ingress of dirt	Plastic roller Sleeve for protection against the ingress of dirt with metal roller available on request
Head can be turned 4 x 90°	■	■
Actuating force	17 N	17 N
Actuating torque	-	-

Switch travel diagrams

Snap action 1 NO / 1 NC

M3S 330-11y

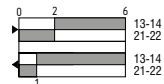

M3R 330-11y

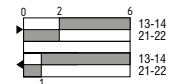



Spring rod lever AF



Fork roller level 4D



Rod lever V.

can be deflected in any direction
Elasticity of the spring allows
for deflection above the max.
switching angle of 15°

Plastic rollers
Actuation head with
90° end-position latching
Continuous adjustment of
lever position 360°
Actuator can be turned
by 180° on the shaft
with metal roller available on request

Low-wear rod lever
Temperature-resistant design
up to +160 °C
incl. 10° gearing, suffix -1366
Shaft and actuator with
10° gearing, suffix -1164

-	■	■
9 N	-	-
-	50.5 Ncm	50.5 Ncm

MAF 330-11y

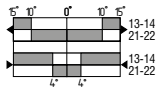

M3V4D 330-11y

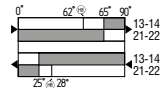

MV. 330-11y

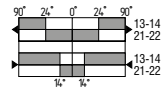

2. Position and limit switches

Series M330 – Actuating elements



Roller lever 8H



Roller lever H

Actuator heads

Actuator description	Roller lever 8H	Roller lever H
Actuator description	Plastic roller Continuous adjustment of lever position 360° Actuator can be turned by 180° on the shaft with metal roller available on request with 10 gearing, suffix -1164	Plastic roller Continuous adjustment of lever position 360° Actuator can be turned by 180° on the shaft with metal roller available on request with 10 gearing, suffix -1164
Head can be turned 4 x 90	■	■
Actuating force	–	–
Actuating torque	24 Ncm	50.5 Ncm

Switch travel diagrams

Snap action 1 NO / 1 NC

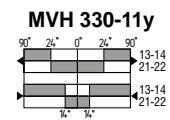
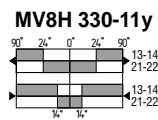



Roller lever 3H



Roller lever 7H



Spring rod lever on shaft 4H

Plastic roller
Continuous adjustment
of lever position 360°
Actuator can be turned
by 180° on the shaft
with metal roller available on request
with 10 gearing, suffix -1164

■

-

50.5 Ncm

Length adjustable metal lever
with plastic roller
Continuous adjustment
of lever position 360°
Actuator can be turned
by 180° on the shaft
with metal roller available on request

■

-

50.5 Ncm

Spring with rod
Continuous adjustment
of lever position 360°
Actuator can be turned
by 180° on the shaft

-

-

50.5 Ncm

MV3H 330-11y

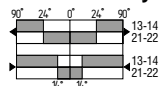

MV7H 330-11y

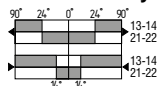

MV4H 330-11y



2. Position and limit switches

Series M330 – Actuating elements



Rod lever 9H

Rod lever 10H

Actuator heads

Actuator description	Rod lever 9H	Rod lever 10H
Actuator description	Stainless steel round rod Continuous adjustment of lever position 360° Actuator can be turned by 180° on the shaft	Plastic rod Continuous adjustment of lever position 360° Actuator can be turned by 180° on the shaft Rod available in aluminium or stainless steel
Head can be turned 4 x 90°	■	■
Actuating force	-	-
Actuating torque	50.5 Ncm	50.5 Ncm

Switch travel diagrams

Snap action 1 NO / 1 NC

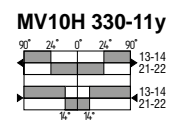
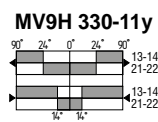



Leaf spring rod lever 2H



Leaf spring lever 6H

Epoxy-resin leaf spring
 Leaf spring thickness 2.5 mm
 Continuous adjustment
 of lever position 360°
 Actuator can be turned
 by 180° on the shaft

Spring-steel leaf spring
 Leaf spring thickness 0.8 mm
 Continuous adjustment
 of lever position 360°
 Actuator can be turned
 by 180° on the shaft



-

-

50.5 Ncm

50.5 Ncm

MV2H 330-11y

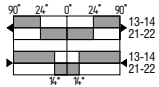

MV6H 330-11y

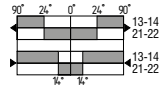

2. Position and limit switches

Series M330 – Preferred types



Series	Switching system	Contacts	Actuator	Special features	Type designation	Material number
M 330	Snap action	1 NO / 1 NC	Telescopic plunger 2 S	---	M2S 330-11Y	101149639
			Angle roller lever 3K	---	M3K 330-11Y	101168054
			Side roller plunger 3R	---	M3R 330-11Y	101161735
			Side plunger 3S	---	M3S 330-11Y	101168055
			Fork roller level 4D	---	M3V4D 330-11Y	101165920
			Spring rod lever AF	---	MAF 330-11Y	101160633
			Offset roller lever K	---	MK 330-11Y	101163173
				---	MR 330-11Y	101165677
			Roller plunger R	Temperature-resistant design up to +160 °C	MR 330-11Y-1366	101162603
				---	MS 330-11Y	101160614
			Plunger S	Temperature-resistant design up to +160 °C	MS 330-11Y-1366	101164485
			Rod lever V.	---	MV. 330-11Y	101164341
				---	MV10H 330-11Y	101168057
			Rod lever 10H	Temperature-resistant design up to +160 °C incl. 10° gearing	MV10H 330-11Y-1366	101174397
			Leaf spring rod lever 2H	---	MV2H 330-11Y	101057633
				---	MV3H 330-11Y	101168052
			Roller lever 3H	Temperature-resistant design up to +160 °C incl. 10° gearing	MV3H 330-11Y-1366	101057642
				---	MV4H 330-11Y	101168053
			Spring rod lever on shaft 4H	Temperature-resistant design up to +160 °C incl. 10° gearing	MV4H 330-11Y-1366	101057649
			Leaf spring lever 6H	---	MV6H 330-11Y	101149664
		---	MV7H 330-11Y	101158933		
	Roller lever 7H	Temperature-resistant design up to +160 °C incl. 10° gearing	MV7H 330-11Y-1366	101160085		
		---	MV9H 330-11Y	101168056		
	Rod lever 9H	Temperature-resistant design up to +160 °C incl. 10° gearing	MV9H 330-11Y-1366	101168903		
		---	MVH 330-11Y	101160129		
	Roller lever H	Temperature-resistant design up to +160 °C incl. 10° gearing	MVH 330-11Y-1366	101166264		
	Operating lever as accessory			Leaf spring lever 6H	101064152	
			Spring rod lever on shaft 4H	101064151		
			Roller lever 3H	101064143		
			Roller lever 7H	101064153		
			Roller lever H	101064128		
			Rod lever 10H	101064157		
			Rod lever 9H	101064156		

2. Position and limit switches

Series M330 – Ordering code



MV7H 330-11Y-G24-1366

Actuator selection

S	Plunger
2NO	Telescopic plunger
R	Roller plunger
K	Offset roller lever
3K	Angle roller lever
3NO	Side plunger
3R	Side roller plunger
AF	Spring rod lever
4D	Fork roller lever
V.	Rod lever
H	Roller lever H
3H	Roller lever 3H
7H	Roller lever 7H
4H	Spring rod lever on shaft 4H
9H	Rod lever 9H
10H	Rod lever 10H
2H	Leaf spring rod lever 2H
6H	Leaf spring lever 6H

Special versions

AuNi	Gold-nickel alloy contacts
1164	Shaft and actuator with 10° gearing
1366	Temperature-resistant design to +160 °C incl. 10° gearing for swivel levers
LED	
	without LED
G24	with LED

For technical reasons, not all possible variations and/or combinations can be delivered. The existing key type is used to translate the product type designation.

To see a wide range of other types, visit www.schmersal.net.

2. Position and limit switches

Series S0 – Actuating elements



Plunger S

Telescopic plunger 2 S

Actuator heads

Actuator description	Thermoplastic plunger	Actuator head with captive stainless steel ball actuator With large after-travel Available with bellows to protect against coarse dirt, ordering suffix -q
Head can be turned 4 x 90°	-	-
Actuating speed	max. 1 m/s	max. 1 m/s
Vertical actuating angle	max.20°	max.20°
from right	-	-
from left	-	-

Switch travel diagrams

Snap action 1 NO / 1 NC	MS 015-11y 	M2S 015-11y
Slow action 1 NO / 1 NC	TS 015-11y 	T2S 015-11y
2 NC	TS 015-02y 	T2S 015-02y
2 NO	TS 015-20y 	T2S 015-20y

The switching distances of the contacts in series T 016 and T/M 017 correspond to series T/M 015.



Offset roller lever K



Tilt lever 2K



Angle roller lever 3K

Plastic roller
Actuator head can be repositioned
in steps 4 x 90°
with metal roller available on request

Plastic roller
Actuation only possible from left
Free movement of actuator from right
Actuator head can be repositioned
in steps 4 x 90°
with metal roller available on request

Plastic roller
Actuation parallel to axis
of switch from below
Actuator head can be repositioned
in steps 4 x 90°
with metal roller available on request

-

max. 0.5 m/s

-

max.30°

max.45°

-

max. 0.5 m/s

-

max.60°

max.45°

-

max. 0.5 m/s

max.45°

-

-

MK 015-11y

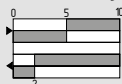

TK 015-11y



TK 015-02y

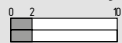

TK 015-20y



M2K 015-11y

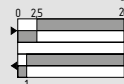

T2K 015-11y



T2K 015-02y

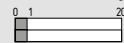

T2K 015-20y



M3K 015-11y

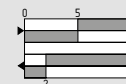

T3K 015-11y



T3K 015-02y

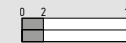

T3K 015-20y



■ Contact closed
□ Contact open

2. Position and limit switches

Series S0 – Actuating elements



Rod lever V.

Roller lever 8H

Actuator heads

Actuator description	Shaft and actuator available with gearing, suffix -1164	Plastic roller Continuous adjustment of lever position 360° Actuator can be turned by 180° on the shaft with metal roller available on request
Head can be turned 4 x 90°	■	■
Actuating speed	max. 3 m/s	max. 3 m/s
Vertical actuating angle	–	–
from right	max.30°	max.30°
from left	max.30°	max.30°

Switch travel diagrams

Snap action	1 NO / 1 NC	MV. 015-11y 	MV8H 015-11y
Slow action	1 NO / 1 NC	TV. 015-11y 	TV8H 015-11y
	2 NC	TV. 015-02y 	TV8H 015-02y
	2 NO	TV. 015-20y 	TV8H 015-20y

The switching distances of the contacts in series T 016 and T/M 017 correspond to series T/M 015.



Roller lever H	Roller lever 3H	Roller lever 7H
Plastic roller Continuous adjustment of lever position 360° Actuator can be turned by 180° on the shaft with metal roller available on request	Plastic roller Continuous adjustment of lever position 360° Actuator can be turned by 180° on the shaft with metal roller available on request	Length adjustable metal lever with plastic roller Continuous adjustment of lever position 360° Actuator can be turned by 180° on the shaft with metal roller available on request
■	■	■
max. 3 m/s	max. 3 m/s	max. 3 m/s
-	-	-
max.30°	max.30°	max.30°
max.30°	max.30°	max.30°

MVH 015-11y 	MV3H 015-11y 	MV7H 015-11y
TVH 015-11y 	TV3H 015-11y 	TV7H 015-11y
TVH 015-02y 	TV3H 015-02y 	TV7H 015-02y
TVH 015-20y 	TV3H 015-20y 	TV7H 015-20y

Contact closed
 Contact open

2. Position and limit switches

Series S0 – Actuating elements



Spring rod lever on shaft 4H

Rod lever 9H

Actuator heads

Actuator description	Spring rod lever on shaft 4H	Rod lever 9H
Actuator description	Elasticity of spring allows for inexact movement of actuator Continuous adjustment of lever position 360° Actuator can be turned by 180° on the shaft	Steel rod Continuous adjustment of lever position 360° Actuator can be turned by 180° on the shaft
Head can be turned 4 x 90°	■	■
Actuating speed	max. 3 m/s	max. 3 m/s
Vertical actuating angle	–	–
from right	max.30°	max.30°
from left	max.30°	max.30°

Switch travel diagrams

Snap action	1 NO / 1 NC	MV4H 015-11y	MV9H 015-11y
Slow action	1 NO / 1 NC	TV4H 015-11y	TV9H 015-11y
	2 NC	TV4H 015-02y	TV9H 015-02y
	2 NO	TV4H 015-20y	TV9H 015-20y

The switching distances of the contacts in series T 016 and T/M 017 correspond to series T/M 015.



Rod lever 10H	Leaf spring rod lever 2H	Leaf spring lever 6H
----------------------	---------------------------------	-----------------------------

<p>Epoxy resin rod Continuous adjustment of lever position 360° Actuator can be turned by 180° on the shaft</p>	<p>Epoxy-resin leaf spring Leaf spring thickness 2.5 mm Continuous adjustment of lever position 360° Actuator can be turned by 180° on the shaft</p>	<p>Spring-steel leaf spring Leaf spring thickness 0.8 mm Continuous adjustment of lever position 360° Actuator can be turned by 180° on the shaft</p>
■	■	■
max. 3 m/s	max. 3 m/s	max. 3 m/s
-	-	-
max.30°	max.30°	max.30°
max.30°	max.30°	max.30°

<p>MV10H 015-11y</p>	<p>MV2H 015-11y</p>	<p>MV6H 015-11y</p>
<p>TV10H 015-11y</p>	<p>TV2H 015-11y</p>	<p>TV6H 015-11y</p>
<p>TV10H 015-02y</p>	<p>TV2H 015-02y</p>	<p>TV6H 015-02y</p>
<p>TV10H 015-20y</p>	<p>TV2H 015-20y</p>	<p>TV6H 015-20y</p>

Contact closed
 Contact open

2. Position and limit switches

Series S0 – Preferred types



Series	Switching system	Contacts	Actuator	Type designation	Material number
 S0	Snap action	1 NO / 1 NC	Telescopic plunger - 2 S	M2S 015-11Y	101160497
			Offset roller lever K	MK 015-11Y	101160412
			Plunger S	MS 015-11Y	101170443
			Rod lever V.	MV. 015-11Y	101174600
			Roller lever 3H	MV3H 015-11Y	101058452
			Roller lever H	MVH 015-11Y	101160442
	Slow action	1 NO / 1 NC	Plunger S	TS 015-11Y	101170456
			Tilt lever 2K	T2K 015-11Y	101170062
			Telescopic plunger - 2 S	T2S 015-11Y	101161467
	Slow action	2 NC	Offset roller lever K	TK 015-02Y	101054782
		2 NO / 1 NC	Telescopic plunger - 2 S	T2S 016-21Y	101054869
			Plunger S	TS 016-03Y	101168064
		3 NC	Rod lever V.	TV. 016-03Y	101060212
	2 NO / 2 NC		Offset roller lever K	MK 017-22Y	101164045
		TK 017-22Y		101054954	
	Snap action	Operating lever as accessory		Leaf spring lever 6H	101064152
	Slow action			Spring rod lever on shaft 4H	101064151
				Roller lever 3H	101064143
				Roller lever 7H	101064153
				Roller lever 8H	101064239
Roller lever H				101064128	
Rod lever 10H				101064157	
Rod lever 9H				101064156	

2. Position and limit switches

Series S0 – Ordering code



MV3H 015-11Y-C

Switching system

T	Slow action ⊖
M	Snap action

Actuator selection

S	Plunger
2NO	Telescopic plunger
K	Offset roller lever
2K	Tilt lever
3K	Angle roller lever
V.	Rod lever
8H	Roller lever 8H
H	Roller lever H
3H	Roller lever 3H
7H	Roller lever 7H
4H	Spring rod lever on shaft 4H
9H	Rod lever 9H
10H	Rod lever 10H
6H	Leaf spring lever 6H

Special versions

Ü	Slow action with overlapping contacts
H	Slow action with staggered contacts
C	Magnetic blow-out

Contacts

02	2 NC
03	3 NC
11	1 NO/1 NC
12	2 NO/1 NC
13	3 NO/1 NC
20	2 NO
21	1 NO/2 NC
22	2 NO/2 NC
30	3 NO
31	1 NO/3 NC

Enclosure selection

015	Metal enclosure with 2 contacts
016	Metal enclosure with 3 contacts
017	Metal enclosure with 4 contacts

For technical reasons, not all possible variations and/or combinations can be delivered. The existing key type is used to translate the product type designation.

To see a wide range of other types, visit www.schmersal.net.

2. Position and limit switches

Series S1 – Actuating elements



Plunger S



Telescopic plunger - 2 S

Actuator heads

Actuator description	Plunger	Actuator with captive metal ball With large after-travel Available with bellows to protect against coarse dirt, ordering suffix -q
Head can be turned 4 x 90°	-	-
Actuating speed	max. 1 m/s	max. 1 m/s
Vertical actuating angle	max.20°	max.20°
from right	-	-
from left	-	-

Switch travel diagrams

Snap action	1 NO / 1 NC	MS 441-11y 	M2S 441-11y
Slow action	1 NO / 1 NC	TS 441-11y 	T2S 441-11y
	1 NC	TS 422-01y 	T2S 422-01y
	1 NO	TS 422-10y 	T2S 422-10y

The switching distances of the contacts in series T 452 and T/M 461 correspond to series T/M 441 and T 422.



Roller plunger R



Offset roller lever K



Offset roller lever J

Plastic roller Actuator can be turned by 90° with metal roller available on request	Plastic roller Actuation only possible from left Actuator head can be repositioned in steps 4 x 90° with metal roller available on request	Plastic roller Actuation only possible from left Actuator head can be repositioned in steps 4 x 90° with metal roller available on request
–	–	–
max. 0.5 m/s	max. 0.5 m/s	max. 0.5 m/s
–	–	–
max.30°	max.30°	max.30°
max.30°	max.45°	max.45°

<p>MR 441-11y</p>	<p>MK 441-11y</p>	<p>MJ 441-11y</p>
<p>TR 441-11y</p>	<p>TK 441-11y</p>	<p>TJ 441-11y</p>
<p>TR 422-01y</p>	<p>TK 422-01y</p>	<p>TJ 422-01y</p>
<p>TR 422-10y</p>	<p>TK 422-10y</p>	<p>TJ 422-10y</p>

2. Position and limit switches

Series S1 – Actuating elements



Fork lever 2C



Roller lever L

Actuator heads

Actuator description	Fork lever 2C	Roller lever L
with end-position latching Actuator head can be repositioned in steps 4 x 90° Changes to the actuation direction by turning the actuator Surface-hardened actuator		Plastic roller Continuous adjustment of lever position 360° Actuator can be turned by 180° on the shaft with metal roller available on request Shaft and actuator with gearing, suffix -1801
Head can be turned 4 x 90°	–	■
Actuating speed	max. 0.5 m/s	max. 3 m/s
Vertical actuating angle	–	–
from right	–	max.30°
from left	–	max.30°

Switch travel diagrams

Snap action	1 NO / 1 NC	M2C 441-11y 	ML 441-11y
Slow action	1 NO / 1 NC	T2C 441-11y 	TL 441-11y
	1 NC	T2C 422-01y 	TL 422-01y
	1 NO	T2C 422-10y 	TL 422-10y

The switching distances of the contacts in series T 452 and T/M 461 correspond to series T/M 441 and T 422.



Roller lever D

Plastic roller
 Continuous adjustment
 of lever position 360°
 Actuator can be turned
 by 180° on the shaft
 with metal roller available on request
 Shaft and actuator with gearing,
 suffix -1801

max. 3 m/s

-

max.30°

max.30°

MD 441-11y



TD 441-11y

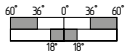

TD 422-01y

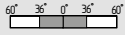

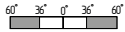

TD 422-10y



2. Position and limit switches

Series S1 – Preferred types



Series	Switching system	Contacts	Actuator	Special features	Type designation	Material number		
 	Slow action	1 NO	Roller lever D	---	TD 422-10Y	101059468		
		1 NC		Roller plunger R	---	TD 422-01Y	101170460	
			Fork lever 2C	---	TR 422-01Y	101058682		
			Roller lever L	---	T2C 422-01Y	101059651		
		1 NO	Roller lever L	---	TL 422-01Y	101168785		
	Snap action	1 NO / 1 NC			---	TL 422-10Y	101059278	
					---	M. 441-11Y	101170470	
					-40°C ... +200°C	M. 441-11Y-T	101170473	
					Fork lever 2C	---	M2C 441-11Y	101059676
					Telescopic plunger 2 S	---	M2S 441-11Y	101058560
					Offset roller lever J	---	MJ 441-11Y	101059115
					Offset roller lever K	---	MK 441-11Y	101058945
					Roller lever L	---	ML 441-11Y	101170496
					-40°C ... +200°C	ML 441-11Y-T	101170498	
					Roller plunger R	---	MR 441-11Y	101058758
	Slow action	1 NO / 1 NC			---	MS 441-11Y	101169605	
					---	T. 441-11Y	101162538	
					-40°C ... +200°C	T. 441-11Y-T	101056534	
					Fork lever 2C	---	T2C 441-11Y	101059661
					Roller lever D	---	TD 441-11Y	101170463
					Offset roller lever K	---	TK 441-11Y	101058908
					Roller lever L	---	TL 441-11Y	101059310
	Roller plunger R	---	TR 441-11Y	101171772				
	Slow action. with staggered contacts	2 NO / 2 NC			---	T. 454-22Z-H	103013113	
	Snap action	2 NO / 2 NC	Roller lever D		---	MD 461-22Y	101059618	
	Operating lever as accessory					Roller lever D	101064671	
						Roller lever L	101064609	

2. Position and limit switches

Series S1 – Ordering code



M2C 441-11Y-1276-2

Switching system

T	Slow action ⊖
M	Snap action

Actuator selection

S	Plunger
2NO	Telescopic plunger
R	Roller plunger
K	Offset roller lever
J	Offset roller lever
2C	Fork lever
L	Roller lever L
D	Roller lever D

Enclosure selection

422	Metal enclosure with 1 contact
441	Metal enclosure with 2 contacts
454	Metal enclosure with 2 or 4 contacts
461	Metal enclosure with 3 or 4 contacts

Special versions

T	Tropic and temperature-resistant version -40 °C to +200 °C
1276-2	Gold-plated contacts

Contacts

01	1 NC
02	2 NC
03	3 NC
10	1 NO
11	1 NO/1 NC
12	2 NO/1 NC
13	3 NO/1 NC
20	2 NO
21	1 NO/2 NC
22	2 NO/2 NC
30	3 NO
31	1 NO/3 NC

For technical reasons, not all possible variations and/or combinations can be delivered. The existing key type is used to translate the product type designation.

To see a wide range of other types, visit www.schmersal.net.

2. Position and limit switches

Series U – Actuating elements



Plunger S



Offset roller lever K

Actuator heads

Actuator description	Plunger Switching points and contact type adjustable	Plastic roller with metal roller available on request Switching points and contact type adjustable
Head can be turned 4 x 90°		
Actuating speed	max. 0.5 m/s	max. 0.5 m/s
Vertical actuating angle	max.20°	-
from right	-	max.30°
from left	-	max.45°
Actuator weight	-	-

Switch travel diagrams

Slow action Optionally
adjustable
NO contact or
NC contact

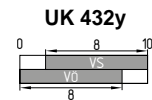
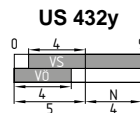

Contact function, i. e. NC or NO contact, and switching points can be adjusted using a screwdriver.
On request, the contact type and switching points can also be supplied as adjustable.
On swivel levers, each contact setting is effective in both directions of rotation.



Rod lever V



Roller lever 8H



Roller lever H

Shaft and actuator available with gearing, suffix -1164
Switching points and contact type adjustable

Plastic roller
Shaft and actuator available with gearing with metal roller, ordering suffix -RMS
Switching points and contact type adjustable

Plastic roller
Shaft and actuator available with gearing with metal roller, ordering suffix -RMS
Switching points and contact type adjustable

max. 3 m/s

-

max.30°

max.30°

-

max. 3 m/s

-

max.30°

max.30°

25 g

max. 3 m/s

-

max.30°

max.30°

45 g

UV. 432y

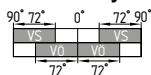

UV8H 432y

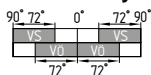

UVH 432y

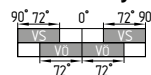

Key

VS: Adjustment range, NO contact
VO: Adjustment range, NC contact
N: After-travel

2. Position and limit switches

Series U – Actuating elements



Roller lever 3H

Roller lever 7H

Actuator heads

Actuator description	Roller lever 3H	Roller lever 7H
Actuator description	Plastic roller Shaft and actuator available with gearing with metal roller, ordering suffix -RMS Switching points and contact type adjustable	Length adjustable metal lever with plastic roller with metal roller, ordering suffix -RMS Switching points and contact type adjustable
Head can be turned 4 x 90°		
Actuating speed	max. 3 m/s	max. 3 m/s
Vertical actuating angle	-	-
from right	max.30°	max.30°
from left	max.30°	max.30°
Actuator weight	95 g	105 g

Switch travel diagrams

Slow action Optionally adjustable
NO contact or NC contact

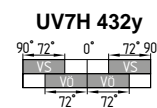
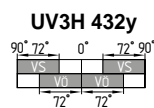

Contact function, i. e. NC or NO contact, and switching points can be adjusted using a screwdriver. On request, the contact type and switching points can also be supplied as adjustable. On swivel levers, each contact setting is effective in both directions of rotation.



Spring rod lever on shaft 4H

Rod lever 9H

Rod lever 10H

Spring rod lever on shaft
Switching points and
contact type adjustable

Steel rod
Switching points and
contact type adjustable

Plastic rod
Switching points and
contact type adjustable

max. 3 m/s

max. 3 m/s

max. 3 m/s

-

-

-

max.30°

max.30°

max.30°

max.30°

max.30°

max.30°

105 g

90 g

75 g

UV4H 432y

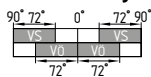

UV9H 432y

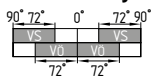

UV10H 432y

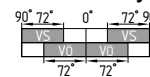

Key

VS: Adjustment range, NO contact
VO: Adjustment range, NC contact
N: After-travel

2. Position and limit switches

Series U – Actuating elements



Leaf spring rod lever 2H

Leaf spring lever 6H

Actuator heads

Actuator description	Epoxy-resin leaf spring Leaf spring thickness 2.5 mm	Spring-steel leaf spring Leaf spring thickness 0.8 mm
Head can be turned 4 x 90°		
Actuating speed	max. 3 m/s	max. 3 m/s
Vertical actuating angle	-	-
from right	max.30°	max.30°
from left	max.30°	max.30°
Actuator weight	85 g	85 g

Switch travel diagrams

Slow action Optionally
adjustable
NO contact or
NC contact

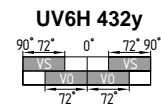
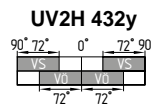

Key

VS: Adjustment range, NO contact
VO: Adjustment range, NC contact
N: After-travel

Contact function, i. e. NC or NO contact, and switching points can be adjusted using a screwdriver.
On request, the contact type and switching points can also be supplied as adjustable.
On swivel levers, each contact setting is effective in both directions of rotation.

2. Position and limit switches

Series U – Preferred types and ordering code



Series	Switching system	Contacts	Actuator	Type designation	Material number
U 432/434 	Slow action	2 NC	Offset roller lever K	UK 432Y	101166388
			Plunger S	US 432Y	101176036
			Rod lever V.	UV. 432Y	101162761
			Rod lever 10H	UV10H 432Y	101060554
			Roller lever 3H	UV3H 432Y	101060537
			Rod lever 9H	UV9H 432Y	101060553
			Roller lever H	UVH 432Y	101161093
	Operating lever as accessory	2 NO / 2 NC	Plunger S	US 434Y	101176035
			Leaf spring lever 6H		101064152
			Spring rod lever on shaft 4H		101064151
			Roller lever 3H		101064143
			Roller lever 7H		101064153
			Roller lever 8H		101064239
			Roller lever H		101064128
		Rod lever 10H		101064157	
		Rod lever 9H		101064156	

UV10H 432Y-2S-1172

Actuator selection		Special versions	
S	Plunger	1172	Low-temperature design to -30 °C
K	Offset roller lever	Contacts	
V.	Rod lever	Series 432 with 2 contacts	
8H	Roller lever 8H		2 NC
H	Roller lever H	2NO	2 NO
3H	Roller lever 3H	1NO/1NC	1 NO/1 NC contacts
7H	Roller lever 7H	Series 434 with 4 contacts	
4H	Spring rod lever on shaft 4H		2 NO/2 NC contacts
9H	Rod lever 9H	4NC	4 NC
Enclosure selection		4NO	4 NO
432	Metal enclosure with 2 contacts	1NO/3NC	3 NO/1 NC contacts
434	Metal enclosure with 4 contacts	3NO/1NC	1 NO/3 NC contacts

For technical reasons, not all possible variations and/or combinations can be delivered. The existing key type is used to translate the product type designation.

To see a wide range of other types, visit www.schmersal.net.

2. Position and limit switches

Series S3 – Actuating elements





Roller lever 2L

Actuator heads

Actuator description	Metal roller Ball-bearing mounted switching shaft
Head can be turned 4 x 90°	■
Actuating speed	max. 1 m/s
Vertical actuating angle	–
from right	max.30°
from left	max.30°

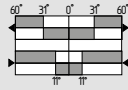
Switch travel diagrams

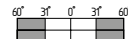
Snap action	1 NO / 1 NC	M2L 035-11z 
Slow action	1 NO / 1 NC	
	2 NC	T2L 035-02z 
	2 NO	T2L 035-20z 

2. Position and limit switches

Series S3 – Actuating elements



Roller lever D

Actuator heads

Actuator description	Plastic roller Switching mechanism can be set for switching: right, left or in both directions
Head can be turned 4 x 90°	-
Actuating speed	max. 3 m/s
Vertical actuating angle	-
from right	max.30°
from left	max.30°



Switch travel diagrams

Snap action	1 NO / 1 NC	MD 250-11z
Slow action	1 NO / 1 NC	TD 250-11z
	2 NC	TD 250-02z
	2 NC contact to the left 2 NC contact to the right	TD 250-02/02z

2. Position and limit switches

Series S3 – Preferred types



Series	Switching system	Contacts	Actuator	Type designation	Material number	
S3	T/M 035 	Slow action	Roller lever 2L	T2L 035-02Z	101056296	
				2 NO	T2L 035-20Z	101056298
	T/M 250 	Snap action	1 NO / 1 NC	Roller lever D	MD 250-11Z	101057965
		Slow action	1 NC to the right/ 1 NC to the left		TD 250-01/01Z	101058138
			2 NC to the right/ 2 NC to the left		TD 250-02/02Z	101058179
			2 NC contact		TD 250-02Z	101057989
			1 NO/1 NC to the right/ 1 NO/1 NC to the left		TD 250-11/11Z	101058150
			2 NO / 2 NC		TD 250-22Z	101058095

2. Position and limit switches

Series S3 – Ordering code



T2L 035-02ZÜ-C

Switching system

T	Slow action ⊖
M	Snap action

Contacts

02	2 NC
11	1 NO/1 NC contacts
20	2 NO

Special versions

	Without
C	Magnetic blow-out

Special versions

Ü	Slow action with overlapping contacts
H	Slow action with staggered contacts

TD 250-11/11ZÜ-R-T

Switching system

T	Slow action ⊖
M	Snap action

Contacts

02	2 NC
11	1 NO/1 NC contacts
01/01	1 NC to the right/1 NC to the left
02/02	2 NC to the right/2 NC to the left
11/11	1 NO/1 NC to the right/ 1 NO/1 NC to the left

Special versions

T	Tropic and temperature-resistant version -40 °C to +200 °C
1276-2	Gold-plated contacts

Special versions

C	Magnetic blow-out
R	Latching 2 x 45°

Special versions

	Without
Ü	Slow action with overlapping contacts

For technical reasons, not all possible variations and/or combinations can be delivered. The existing key type is used to translate the product type designation.

To see a wide range of other types, visit www.schmersal.net.

2. Position and limit switches

Series S2 – Actuating elements



Plunger S



Offset roller lever J

Actuator heads

Actuator description	Plunger Roller levers J and X can be subsequently fitted at plunger S	Plastic roller with metal roller available on request available with rubber roller, suffix -1
Head can be turned 4 x 90°	–	■
Actuating speed	max. 1 m/s	max. 0.5 m/s
Vertical actuating angle	max.20°	–
from right	–	max.45°
from left	–	max.30°

Switch travel diagrams

Slow action	Per NO contact / per NC contact	TS 064 	TJ 064
Per NO contact / per NC contact			
Per NO contact / per NC contact			
Per NO contact / per NC contact			
Snap action	Per NO contact / per NC contact	MS 064 	MJ 064
Per NO contact / per NC contact			
Per NO contact / per NC contact			

These actuators can only be used with series TS/MS 064.
Roller levers J and X can be subsequently fitted at plunger S



Offset roller lever X



Roller lever L



Roller lever A

Plastic roller
with metal roller available on request

Plastic roller
with metal roller available on request
available with rubber roller, suffix -1
Continuous adjustment
of lever position 360°

Plastic roller
with metal roller available on request
available with rubber roller, suffix -1
Continuous adjustment
of lever position 360°

max. 0.5 m/s

max. 3 m/s

max. 3 m/s

max.45°

max.30°

max.30°

max.30°

max.30°

max.30°

TX 064

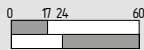

TL 064-11Y

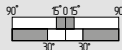

TA 064-11Y

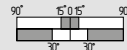

TL 064-01Y

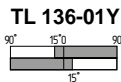

TL 064-10Y

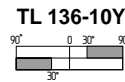

TL 136-01Y

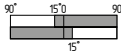

TL 136-10Y

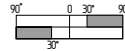

TA 064-01Y

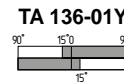

TA 064-10Y

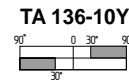

TA 136-01Y

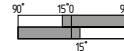

TA 136-10Y

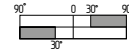

TL 471-11Y

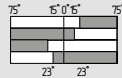

TA 471-11Y

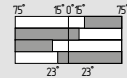

TL 130-01Y



TL 130-10Y

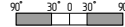

TA 130-01Y

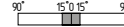

TA 130-10Y

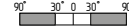

MX 064

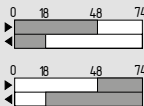

ML 471-11Y

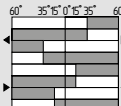

ML 471-11Y-Li

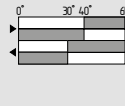

MA 471-11Y

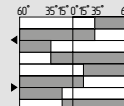

MA 471-11Y-Li

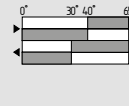

ML 064-01Y

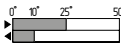

ML 064-01Y-Li

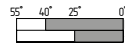

MA 064-01Y

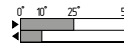

MA 064-01Y-Li

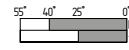

ML 064-10Y



ML 064-10Y-Li

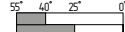

MA 064-10Y



MA 064-10Y-Li

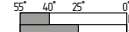

2. Position and limit switches

Series S2 – Actuating elements



Roller lever 2A

Roller lever V

Actuator heads

Actuator description	Roller lever 2A	Roller lever V
Actuator description	Plastic roller with metal roller available on request available with rubber roller, suffix -1 Continuous adjustment of lever position 360°	Plastic roller with metal roller available on request available with rubber roller, suffix -1 Continuous adjustment of lever position 360°
Head can be turned 4 x 90°	-	-
Actuating speed	max. 3 m/s	max. 3 m/s
Vertical actuating angle	-	-
from right	max.30°	max.30°
from left	max.30°	max.30°

Switch travel diagrams

Slow action	Per NO contact / per NC contact	T2A 064-11Y 		TV 064-11Y 	
	Per NO contact / per NC contact	T2A 064-01Y T2A 136-01Y 	T2A 064-10Y T2A 136-10Y 	TV 064-01Y TV 136-01Y 	TV 064-10Y TV 136-10Y
	Per NO contact / per NC contact	T2A 471-11Y 		TV 471-11Y 	
Snap action	Per NO contact / per NC contact	T2A 130-01Y 	T2A 130-10Y 	TV 130-01Y 	TV 130-10Y
	Per NO contact / per NC contact	M2A 471-11Y 	M2A 471-11Y-Li 	MV 471-11Y 	MV 471-11Y-Li
	Per NO contact / per NC contact	M2A 064-01Y 	M2A 064-01Y-Li 	MV 064-01Y 	MV 064-01Y-Li
		M2A 064-10Y 	M2A 064-10Y-Li 	MV 064-10Y 	MV 064-10Y-Li



Pull lever Z

Pull lever 2Z

Offset roller lever 4D

Continuous adjustment
of lever position 360°

Continuous adjustment
of lever position 360°

Continuous adjustment
of lever position 360°

max. 3 m/s

max. 3 m/s

max. 3 m/s

max.30°

max.30°

max.30°

max.30°

max.30°

max.30°

TZ 064-11Y

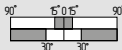

T2Z 064-11Y

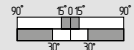

T4D 064-11Y

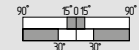

TZ 064-01Y

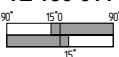

TZ 064-10Y

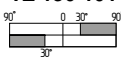

TZ 136-01Y

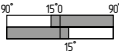

TZ 136-10Y

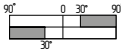

T2Z 064-01Y

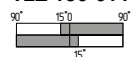

T2Z 064-10Y

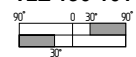

T2Z 136-01Y

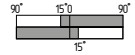

T2Z 136-10Y

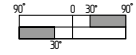

T4D 064-01Y

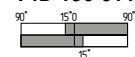

T4D 064-10Y

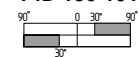

T4D 136-01Y

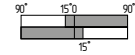

T4D 136-10Y

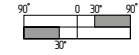

TZ 471-11Y

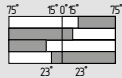

T2Z 471-11Y

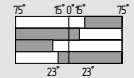

T4D 471-11Y

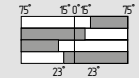

TZ 130-01Y

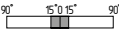

TZ 130-10Y

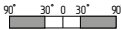

T2Z 130-01Y

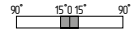

T2Z 130-10Y

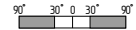

T4D 130-01Y

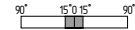

T4D 130-10Y

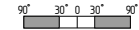

MZ 471-11Y

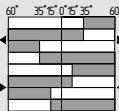

MZ 471-11Y-Li

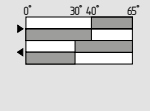

M2Z 471-11Y

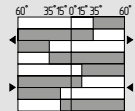

M2Z 471-11Y-Li

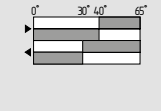

M4D 471-11Y

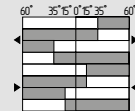

M4D 471-11Y-Li

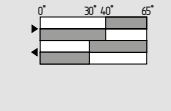

MZ 064-01Y

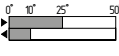

MZ 064-01Y-Li

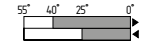

M2Z 064-01Y

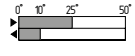

M2Z 064-01Y-Li

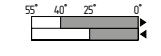

M4D 064-01Y

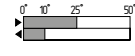

M4D 064-01Y-Li

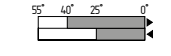

MZ 064-10Y

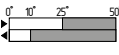

MZ 064-10Y-Li

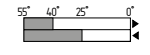

M2Z 064-10Y

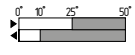

M2Z 064-10Y-Li

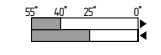

M4D 064-10Y

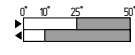



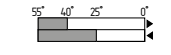

M4D 064-10Y-Li



2. Position and limit switches

Series S2 – Preferred types



Series	Switching system	Contacts	Actuator	Special features	Type designation	Material number	
S2	T/M 064 	Snap action	3 NC	Offset roller lever J	---	MJ 064-03Y	101056945
		Slow action	3 NC	Offset roller lever J	---	TJ 064-03Y	101057481
			1 NO / 2 NC	Plunger S	---	TS 064-12Y	101057473
			2 NO / 1 NC	Pull lever Z	---	TZ 064-21Y	101060723
			3 NC		Latching 2 x 45°	TZ 064-03Y-R=2X45GR.	101116036
			1 NO / 2 NC	Roller lever A	---	TA 064-12Y	101060739
			3 NC		---	TA 064-03Y	101060769
			1 NO / 2 NC	Offset roller lever	Latching 2 x 90°	T4D 064-12Y-R=2X90GR.	101099338
	T./M. 064 	Snap action	1 NO / 2 NC	Rod lever	Actuating direction always 50° right-hand side rotation	M. 064-12Y	101060848
		Slow action	1 NO to the left/ 2 NO to the right	Rod lever	Actuating direction, each time 90° right-hand side and left-hand side rotation	T. 064-10/20Y	101060794
			3 NO			T. 064-30Y	101060756
			2 NO / 1 NC			Latching 1 x 90°	T. 064-21Y-R=1X90GR.
	T/M 471 	Snap action	1 NO/2 NC to the left/ 1 NO/2 NC to the right	Rod lever	Actuating direction, each time 60° right-hand side and left-hand side rotation	M. 471-12/12Y	101061195
		Slow action	2 NC to the left/ 2 NC to the right		Actuating direction, each time 75° right-hand side and left-hand side rotation	T. 471-02/02Y	101061077
	T 130/136 	Slow action	3 NO / 3 NC	Rod lever	---	T. 130-33Y	101061303
				Roller lever	Actuating direction, each time 90° right-hand side and left-hand side rotation	TA 130-30/03Y	101135027
	Operating lever as accessory					Roller lever 2A	101064634
						Roller lever A	101064371
						Roller lever D	101064671
					Roller lever L	101064609	
					Offset roller lever 4D	101065612	
					Pull lever Z	101064387	

2. Position and limit switches

Series S2 – Ordering code



MX 064-22Y-R

Switching system

T	Slow action ⊖
M	Snap action

Actuator selection

S	Plunger
J	Offset roller lever
X	Offset roller lever

Contacts

03	3 NC
12	2 NO/1 NC
21	1 NO/2 NC
30	3 NO
04	4 NC
13	3 NO/1 NC
22	2 NO/2 NC
31	1 NO/3 NC
40	4 NO

Special versions

Ü	Slow action with overlapping contacts
H	Slow action with staggered contacts
R	Latching 2 x 45°

T. 471-02/02Y-Ü-Li

Switching system

T.	Slow action ⊖
M.	Snap action

Enclosure selection

064	Metal enclosure with 3 or 4 contacts
471	Metal enclosure with 4 or 6 contacts
130	Metal enclosure with up to 6 contacts
136	Metal enclosure with up to 10 contacts

Contacts

03	3 NC
04	4 NC
12	2 NO/1 NC contacts
13	3 NO/1 NC contacts
21	1 NO/2 NC contacts
22	2 NO/2 NC contacts
30	3 NO
31	1 NO/3 NC contacts
33	3 NO/3 NC contacts
40	4 NO
01/02	1 NC to the left/2 NC to the right
02/01	2 NC to the left/1 NC to the right
02/02	2 NC to the left/2 NC to the right
03/03	3 NC to the left/3 NC to the right
10/20	1 NC to the left/2 NC to the right
12/12	1 NO/2 NC left/1 NO/2 NC right
20/10	2 NC left/1 NC right
20/20	2 NO to the left/2 NO to the right
21/21	2 NO/1 NC left/2 NO/1 NC right
30/30	3 NO to the left/3 NO to the right

Actuation direction

	Right-hand side rotation
LI	Left-hand side rotation

Special versions

Ü	Slow action with overlapping contacts
H	Slow action with staggered contacts
R	Latching 2 x 45°

The switches are supplied with rod levers. The actuation lever must be ordered as an additional accessory.

Actuator selection

L	Roller lever L
A	Roller lever A
2A	Roller lever 2A
V	Roller lever V
Z	Pull lever Z
2Z	Pull lever 2Z
2C	Fork lever 2C
4D	Offset roller lever 4D

For technical reasons, not all possible variations and/or combinations can be delivered. The existing key type is used to translate the product type designation.

3. Position switches – Special variants

Description

Gear switch

Area of application

Gear limit switches are used in the materials lifting and handling industry, roller doors, stage systems etc. Depending on the contact configuration, they are used for deactivation or for positioning motion sequences. The drive is provided via a shaft.

Design and operating principle

Both the enclosure, which is largely made of a seawater-resistant die-cast alloy housing, and the covers made of shock-resistant thermoplastic resistant to many chemicals are suitable for extreme ambient conditions.

On the basic versions with the transmission ratios 1:50 (G50) and 1:150 (G150) the turns of the drive are transmitted directly to the disc cam via a worm and worm wheel, i. e. the disc cams rotate once by 360° for 50 or 150 turns of the drive shaft.

The switching point of the contact is adjusted on the standard version by undoing the central screw, or conveniently via the disc cam with front setting, e. g. using ordering suffix "1600-1". Along with the standard transmission ratios, other transmission ratios are available.

Rotating spindle limit switches

Area of application

Rotating spindle limit switches are used in, among other areas, machine tools, cranes and material handling plants.

Design and operating principle

The robust cast-iron enclosure with 2-component paint finish is suitable for extreme ambient conditions. The movement range of the spindle of between 4 and 55 turns permits exact switching of the change-over contact with galvanically separated contact bridges.



Slack-wire switches

Area of application

Slack-wire switches are used to monitor the wire tension.

Design and operating principle

A slack, sagging wire, for example here on a material handling plant, releases the normally actuated switch and the plant is switched off.

Belt alignment switches

Area of application

Belt alignment switches monitor the straight running of conveyor plants. If the conveyor belt moves off-centre from the drive and pulleys the switching devices trigger.

Design and operating principle

With staggered switching a pre-warning for example is initiated with 10° deviation and the conveyor belt is switched off for example at 25°. Individual staggered switching is available upon request. In addition to multiple versions of belt alignment switches, Schmersal offers a comprehensive programme of stainless steel rollers with different lengths and diameters. The roller diameter to be selected is dependent on the belt speed.

On staggered or long conveyor systems, the transparency of the system can be increased considerably by using a 2-wire bus connection because the switching condition of all belt alignment switches can be indicated individually with all the other warning messages in a collective indication system. This helps with any troubleshooting and drastically reduces any downtime. The overall installation effort and expenditure is considerably reduced.

3. Position switches – Special variants

Overview of the series



■ G50 / G150



■ MSP 452



■ T/M 441

Key Features

- **Gear switches**
- Up to 8 contacts
- Different cam forms for various switching travels
- Switching point adjustment using disc cams with front setting (e.g. 1600-1)

- **Rotating spindle limit switches**
- 4 contacts
- Movement range 4...55 turns

- **Slack-wire switches**
- 2 contacts
- Suitable for heavy duty

Technical features

Electrical characteristics			
Switching principle	Slow action or snap action, positive break NC contact	Snap action	Slow action or snap action, positive break NC contact
Max. switching capacity U/I	T/M 697: 230 VAC / 4 A Z/T 6881: 230 VAC / 2.5 A	230 VAC / 2.5 A	230 VAC / 4 A
Mechanical data			
Housing material	Metal with shock-resistant thermoplastic cover	Cast iron, 2-component paint finish	Cast iron, 2-component paint finish
Cable entry	2 x M20 x 1.5	2 x M20 x 1.5	2 x M20 x 1.5
Connection	Screw terminals	Screw terminals	Screw terminals
Cable section ¹⁾	max. 2.5 mm ²	3 x 0.75 mm ²	max. 2.5 mm ²
Dimensions (W x H x D)	200 x 114 x 120 mm	118 x 174 x 64 mm	106 x 181 x 63 mm
Ambient conditions			
Ambient temperature	-30 °C ... +80 °C	-30 °C ... +90 °C	-30 °C ... +90 °C
Protection class	IP65	IP65	IP65
Actuator heads	-	-	-

Safety classification

Standards	IEC 60947-5-1	IEC 60947-5-1	IEC 60947-5-1
B_{10D} NC contact	20,000,000	-	2,000,000
Certificates			

Other versions

ATEX / IECEx	-	-	Zone 21, 22
---------------------	---	---	-------------

¹⁾ Including conductor ferrules

To get detailed information about the products and certificates, visit www.schmersal.net.





■ M 330



■ T/M 441



■ T. 454



■ T/M 250

- **Belt alignment switches**
- 2 contacts
- Adjustable length lever with nylon roller
- Belt speeds ≤ 1 m/s

- **Belt alignment switches**
- 2 contacts
- Stainless steel roller
- Belt speeds ≤ 3 m/s (roller $\varnothing 30$ mm)

- **Belt alignment switches**
- 4 contacts
- Stainless steel roller
- 2 switching angles (prewarning, deactivation)
- Exterior parts made of stainless steel
- Optionally with Dupline interface

- **Belt alignment switches**
- 4 contacts
- Stainless steel roller
- Belt speeds ≤ 6 m/s (roller $\varnothing 50$ mm)
- 2 switching angles (prewarning, deactivation)

Snap action with self-cleaning contact	Snap action or slow action	Slow action	Snap action or slow action
230 VAC / 2.5 A	230 VAC / 4 A	230 VAC / 4 A; 24 VDC / 1 A	400 VAC / 6 A
Aluminium die-cast, paint finish	Cast iron, 2-component paint finish	Cast iron, 2-component paint finish	Cast iron, 2-component paint finish
1x M20 x 1.5	2x M20 x 1.5	2x M20 x 1.5	2x M25 x 1.5
Screw terminals max. 2.5 mm ²	Screw terminals max. 2.5 mm ²	Screw terminals max. 2.5 mm ²	Screw terminals max. 2.5 mm ²
40 x 76 x 40 mm	106 x 105 x 63 mm	67 x 130 x 43 mm	62 x 58 x 50 mm
-30 °C ... +90 °C	-30 °C ... +90 °C	-40 °C ... +70 °C	-30 °C ... +90 °C
IP65	IP65	IP66, IP67	IP67
see page 83	see page 83	see page 83	see page 83

IEC 60947-5-1	IEC 60947-5-1	IEC 60947-5-1	IEC 60947-5-1
-	2,000,000	2,000,000	2,000,000

-	Zone 21, 22	Zone 1, 2, 21, 22	Zone 21, 22
---	-------------	-------------------	-------------

3. Position switches – Special variants

Gear switches – cam shapes

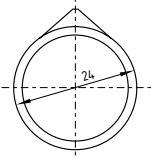
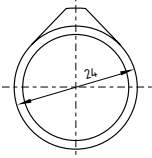
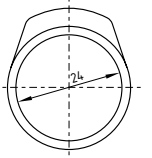
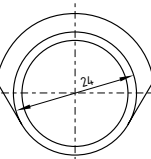
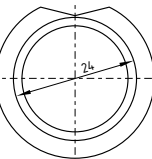
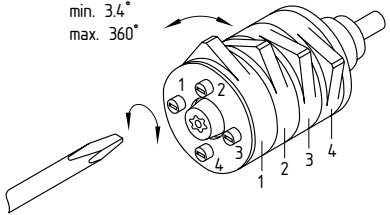
Pointed cam Ø 24 mm 1600-	30° cam Ø 24 mm 2281-	90° cam Ø 24 mm 1601-
 <ul style="list-style-type: none"> ■ Standard cam shapes: pointed cam Ø 24 mm ■ Max. 8 switching elements possible ■ Suitable for front setting 	 <ul style="list-style-type: none"> ■ Standard cam shapes: 30° cam Ø 24 mm ■ Max. 8 switching elements possible ■ Suitable for front setting 	 <ul style="list-style-type: none"> ■ Standard cam shapes: 90° cam Ø 24 mm ■ Max. 8 switching elements possible ■ Suitable for front setting
180° cam Ø 24 mm 2269-	360° solid cam Ø 24 mm 1905-	Pointed cam with front setting -1600-1
 <ul style="list-style-type: none"> ■ Standard cam shapes: 180° cam Ø 24 mm ■ Max. 8 switching elements possible ■ Suitable for front setting 	 <ul style="list-style-type: none"> ■ Standard cam shapes: 360° cam Ø 24 mm ■ Max. 8 switching elements possible ■ Suitable for front setting 	 <ul style="list-style-type: none"> ■ Pointed cam with front setting -1600-1 ■ Example with 4 pointed cams

3. Position switches – Special variants

Belt alignment switches – actuating elements/accessories

Belt alignment lever 243 101065529	Belt alignment lever 966 101095169	Belt alignment lever 1224 101065592
 <ul style="list-style-type: none"> ■ Cast lever with stainless steel roller ■ Roller diameter 25 mm ■ Roller length 50 mm ■ Belt speeds ≤ 1 m/s 	 <ul style="list-style-type: none"> ■ Cast lever with stainless steel roller ■ Roller diameter 32 mm ■ Roller length 65 mm ■ Belt speeds ≤ 3 m/s 	 <ul style="list-style-type: none"> ■ Cast lever with stainless steel roller ■ Roller diameter 32 mm ■ Roller length 100 mm ■ Belt speeds ≤ 3 m/s
LEV-U14-B30-150-RVA 103014651	LEV-U14-B50-150-RVA 103012919	RF-454-DN 103013689
 <ul style="list-style-type: none"> ■ Stainless steel lever with stainless steel roller ■ Roller diameter 30 mm ■ Roller length 155 mm ■ Belt speeds ≤ 3 m/s 	 <ul style="list-style-type: none"> ■ Stainless steel lever with stainless steel roller ■ Roller diameter 50 mm ■ Roller length 155 mm ■ Belt speeds ≤ 6 m/s 	 <ul style="list-style-type: none"> ■ Dupline interface RF-454-DN ■ Monitoring of two floating contacts on the T. 454
Cable gland 103006011	Cable gland 103007570	Screw plug 103006009
 <ul style="list-style-type: none"> ■ M20 x 1,5 cable gland, metal ■ Brass, nickel-plated ■ Authorised cable diameter 6 ... 12 mm ■ Tightening torque 8 Nm 	 <ul style="list-style-type: none"> ■ Cable gland M20 x 1.5 with pressure compensation element ■ Brass, nickel-plated ■ Authorised cable diameter 6 ... 12 mm ■ Tightening torque 3 Nm 	 <ul style="list-style-type: none"> ■ M20 x 1.5 screw plug, metal ■ Brass, nickel-plated ■ Tightening torque 8 Nm

3. Position switches – Special variants

Preferred types

Series	Switching element	Contacts	Special features	Type designation	Material number	
Gear switches	G 50	1NO/1NC		G50-017M11/11Y	101167213	
		1NO/1NC		G50-035M11/11Y	101166487	
		2NO/2NC		G50-025M22/22Y	101166507	
		2NO/2NC		G50-050M22/22Y	101166440	
		3NO/3NC		G50-017M33/33Y	101173256	
		3NO/3NC		G50-050M33/33Y	101166453	
		4NO/4NC		G50-050M44/44Y	101166455	
	Snap action Z	2NO/2NC		G50-035Z22/22Y	101166495	
		2NO/2NC		G50-050Z22/22Y	101166463	
	Slow action T	2NO/2NC	with adjustable pointed cam	G50-017T22/22Y-1600-1	101100246	
	G150	Snap action Z/M	2NO/2NC 4NO/4NC	with adjustable pointed cam	G150-075Z22/M44Y-1600-1	101166383
		Snap action M	1NO/1NC	with adjustable pointed cam	G150-075M11/11Y-1600-1	101094554
			1NO/1NC		G150-150M11/11Y	101173980
		Snap action Z	2NO/2NC		G150-050Z22/22Y	101063401
Slow action T	2NC/2NO		G150-150T02/02Y	101123693		
Rotating spindle limit switches	MSP 452	Snap action	1NO/1NC	MSP 452-11/11Y	101160615	
Slack-wire switches	T/M 441	Snap action	1NO/1NC	with slack-wire lever type 14	M. 441-11Y-14	101058315
		Slow action	1NO/1NC	with slack-wire lever type 14	T. 441-11Y-14	101056537
Belt alignment switches	M 330	Snap action	1NO/1NC	with belt alignment lever 1348	MV10H 330-11Y-1348	101159310
	T/M 441	Snap action	1NO/1NC	with belt alignment lever 243	M. 441-11Y-243	101168784
		Slow action	1NO/1NC	with belt alignment lever 243	T. 441-11Y-243	101170427
		Slow action	1NO/1NC	with belt alignment lever 966	T. 441-11Y-966	101081746
	T. 454	Slow action	2NO/2NC	without belt alignment lever	T. 454-22Z-H	103013113
		Slow action	2NO/2NC	without belt alignment lever, with integrated Dupline interface	T. 454-22Z-H-DN	103014142
	T/M 250	Slow action	1NO/1NC	with belt alignment lever 966	T. 250-02Z-966	101055273
		Slow action	1NO/1NC	with belt alignment lever 966	T. 250-11Z-966	101057959
		Slow action	2NO/2NC	with belt alignment lever 966	T. 250-22Z-966	101058103
		Slow action	2NO/2NC	with belt alignment lever 1224	T. 250-22Z-H-1224	101134281
Snap action		1NO/1NC	with belt alignment lever 1224	M. 250-11Z-1224	101057978	
Snap action		2NO/2NC	with belt alignment lever 1224	M. 250-22Z-1224	101083514	
Slow action	2NO/2NC	with belt alignment lever 1224	T. 250-22Z-1224	101058212		

Up-to-date without fail
Online on the world wide web

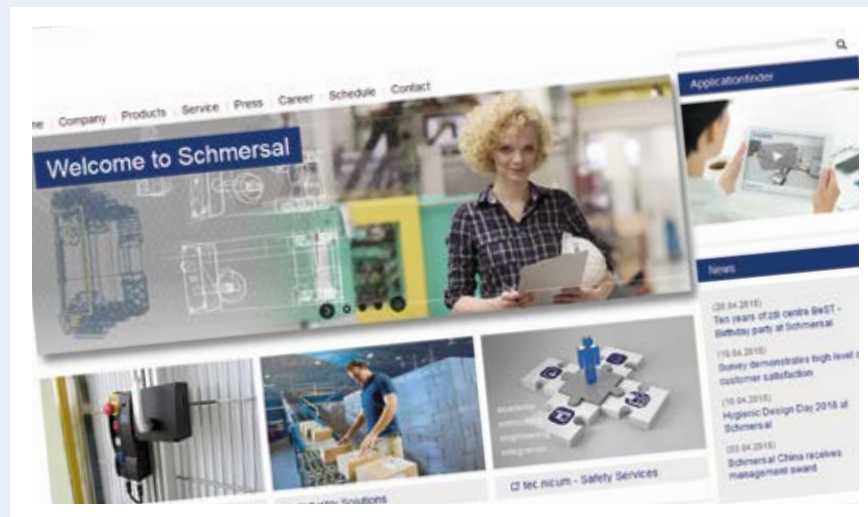

For detailed information, check out
www.schmersal.com

4. Micro switches

Description

Area of application

Micro switches are used as control and precision engineering systems, in apparatus and in vehicle construction. Schmersal devices are designed for industrial applications with stringent quality and reliability requirements.

Design and way of functioning

Minimum space requirements, a high switching capacity and a robust design are just a few of the many benefits of a micro switch. With its internationally standardised mounting and external dimensions, as well as different termination types, switches can be used universally.

Micro switches are available with snap action or slow action and can be combined with a wide range of actuators.

Snap action

Contact where the movement of the switch is abrupt and independent of the actuating speed.

Slow action

Contact where the movement of the switch is independent of the actuating speed.

Positive break

The design of a contact separation as a direct result of a defined movement of the actuator in the switch using non-sprung parts. To guarantee the positive break, the actuator must be actuated with the defined positive break travel.

Friction or self-cleaning contacts

The moving contact bridge is centrally aligned to the V-shaped fixed contact under spring pressure, thereby generating a defined friction. The friction process has a self-cleaning effect on the fixed contacts each time the switch is actuated.

Switching elements

Switches are classified into the following types in accordance with IEC 60947-5-1.



Switching elements

Switching elements may be classified according to one of the following construction form letters:

Type	Contact configuration	Circuit diagram
Type A	NO contact with single break. Switching element with two terminals.	
Type B	NC contact with single break. Switching element with two terminals.	
Type X	NO contact with double break. Switching element with two terminals.	
Type Y	NC contact with double break. Switching element with two terminals.	
Type C	Change-over contact with single break. Switching element with three terminals.	
Type Za	Change-over contact with double break. Switching element with four terminals. The contacts have the same polarity.	
Type Zb	Change-over contact with double break. Switching element with four terminals. The two moving contacts are electrically isolated from one another.	

Micro switches have protection class IP 40, except for versions with rubber casing. In addition, versions with cover for protection against contact with live parts are also available. The following device types are sorted according to enclosure dimensions, starting with the smallest construction form.

4. Micro switches

Overview of the series



■ M 610



■ M 630



■ M 6800 / 6900

Key Features

<ul style="list-style-type: none"> • Change-over contact with single break, type C • Self-cleaning contacts • Telescopic attachment 	<ul style="list-style-type: none"> • Change-over contact with single break, type C • Self-cleaning contacts • Magnetic arc quenching (ordering suffix c) • Reduced actuating force 0.4 N (ordering suffix 934) 	<ul style="list-style-type: none"> • Change-over contact with double break, type Za • Self-cleaning contacts • End-position latching (ordering suffix P2) • Tandem version (ordering suffix P3)
--	--	---

Other versions

Gold contacts	■	-	-
---------------	---	---	---

Technical features

Electrical characteristics			
Switching principle	Snap action with self-cleaning contact	Snap action with self-cleaning contact	Snap action with self-cleaning contact
Thermal test current I_{the}	4 A	10 A	6 A
Max. switching capacity U/I	230 VAC / 2.5 A	230 VAC / 4 A	230 VAC / 4 A
Mechanical data			
Housing material	glass-fibre reinforced thermoplastic	glass-fibre reinforced thermoplastic	thermoplastic
Mechanical life	10 million operations	30 million operations	30 million operations
Connection	Soldering, plug-in or screw terminal	Soldering, plug-in or universal terminal	Soldering, flat plug or universal terminal
Cable section ¹⁾	max. 1.5 mm ²	max. 1.5 mm ²	max. 1.5 mm ²
Dimensions (W x H x D)	19.8 x 11.1 x 6.4 mm	27.8 x 18.3 x 10 mm	32 x 16.6 x 12.6 mm
Ambient conditions			
Ambient temperature	-30 °C ... +85 °C	-30 °C ... +120 °C	-30 °C ... +85 °C
Protection class	Enclosure: IP40; Connections: IP00	Enclosure: IP40; Connections: IP00	Enclosure: IP40; Connections: IP00
Actuator heads	refer to page 90	refer to page 94	refer to page 98

Safety classification

Standards	IEC 60947-5-1	IEC 60947-5-1	IEC 60947-5-1
B_{100} NC contact	20,000,000	20,000,000	20,000,000
Certificates	-	-	-

¹⁾ Including conductor ferrules



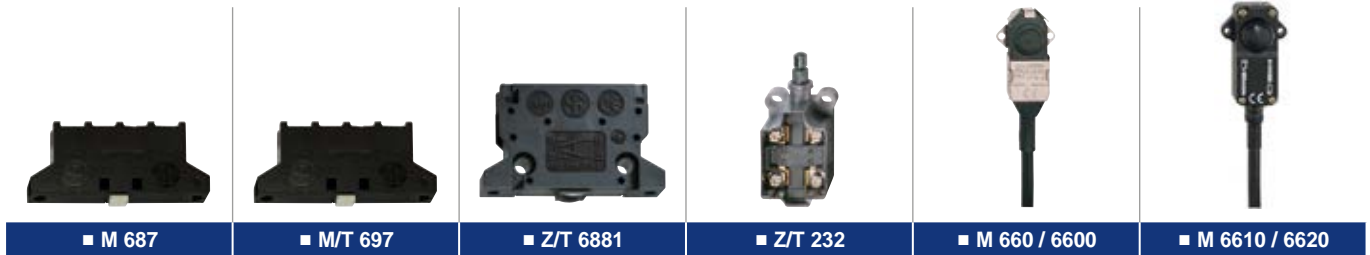

- | | | | | | |
|---|---|---|---|--|--|
| <ul style="list-style-type: none"> • Change-over contact with double break, type Za • Self-cleaning contacts • Slim design | <ul style="list-style-type: none"> • Change-over contact with double break, type Za (snap action) • NC contact with double break, type Y (slow action) • Slim design | <ul style="list-style-type: none"> • Change-over contact with double break, type Zb • Positive break to IEC 60947-5-1 Appendix K • High resistance to vibration and shock • Switching of low voltages | <ul style="list-style-type: none"> • Change-over contact with double break, type Zb • Positive break to IEC 60947-5-1 Appendix K • Contact opening 2 x 2 mm • Plastic plunger | <ul style="list-style-type: none"> • Change-over contact with single break, type C • Self-cleaning contacts • Suitable for aggressive ambient conditions • Protection class IP 65 • Largely resistant to oil and fuel | <ul style="list-style-type: none"> • Change-over contact with single break, type C • Self-cleaning contacts • Suitable for aggressive ambient conditions • Protection class IP 67 • Largely resistant to oil and fuel |
|---|---|---|---|--|--|



Snap action with self-cleaning contact	Snap action Slow action, positive break	Snap/slow action, both positive break	Snap/slow action, both positive break	Snap action with self-cleaning contact	Snap action with self-cleaning contact
6 A	6 A	10 A	10 A	4 A	4 A
230 VAC / 2.5 A	230 VAC / 2.5 A	230 VAC / 2.5 A; 24 VDC / 6 A (600 mm/min) 24 VDC / 5 mA	230 VAC / 4 A 24 VDC / 1 A	230 VAC / 1 A	230 VAC / 1 A
glass-fibre reinforced thermoplastic	glass-fibre reinforced thermoplastic	glass-fibre reinforced thermoplastic	glass-fibre reinforced thermoplastic	Rubber (Perbunan)	glass-fibre reinforced thermoplastic
30 million operations	30 million operations	Z: 1 million switching operations T: 30 million switching operations	20 million operations	3 million operations	3 million operations
g-in terminals	g-in terminals	Screw terminals	Screw terminals	Pre-wired cable 0.5 m	Pre-wired cable 0.5 m
max. 2.5 mm ² 60 x 25 x 11.9 mm	max. 2.5 mm ² 60 x 25 x 11.9 mm	max. 2 x 1.5 mm ² 60 x 35 x 12 mm	max. 2.5 mm ² 27 x 62 x 25 mm	H05VV-F 3 x 0.75 mm ² 32 x 77 x 11.8 mm	H05VV-F 3 x 0.75 mm ² 34 x 62.5 x 18 mm
-30 °C ... +120 °C	-30 °C ... +120 °C	-30 °C ... +85 °C	-30 °C ... +80 °C	-30 °C ... +80 °C	-30 °C ... +80 °C
Enclosure: IP40; Connections: IP00 Index i: IP20 refer to page 102	Enclosure: IP40; Connections: IP00 Index i: IP20 refer to page 102	Enclosure: IP40; Connections: IP00 Index i: IP20 refer to page 103	Enclosure: IP40; Connections: IP00 refer to page 101	IP65 refer to page 104	IP65 refer to page 106

IEC 60947-5-1 20,000,000	IEC 60947-5-1 20,000,000	IEC 60947-5-1 20,000,000	IEC 60947-5-1 20,000,000	IEC 60947-5-1 20,000,000	IEC 60947-5-1 20,000,000
			-	(only M 6600)	-



4. Micro switches

Series M 610 – Actuating elements



Plunger



Actuator 1A

Actuator heads

Actuator description	Plastic cone Can be actuated from all directions	Lever can subsequently be realised in 3 lever bearings		
Lever bearing	-	I	II	III
Actuating travel, total [mm]	1.2	2.70	1.90	1.50
Pre-travel [mm]	-	1.50	1.05	0.80
Max. differential [mm]	-	0.60	0.45	0.35
Actuating force [N]	0.8	0.36	0.52	0.68
Max. ejection force [N]	0.3	0.10	0.14	0.18

Switch travel diagrams

Snap action with self-cleaning contact

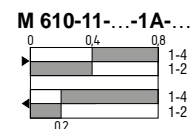
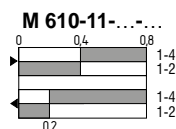



Actuator 1C



Actuator 1E



Actuator 1D

Lever can subsequently be realised in 3 lever bearings

Roller width 2.5 mm
Lever can subsequently be realised in 3 lever bearings

Lever can subsequently be realised in 3 lever bearings

I	II	III	I	II	III	I	II	III
2.10	1.50	1.20	2.60	1.80	1.40	3.50	2.50	1.90
1.20	0.80	0.65	1.45	1.00	0.75	1.90	1.40	1.00
0.50	0.35	0.25	0.55	0.40	0.30	0.80	0.55	0.40
0.47	0.67	0.87	0.38	0.54	0.70	0.28	0.40	0.52
0.13	0.18	0.23	0.11	0.15	0.19	0.08	0.11	0.14

M 610-11-...-1C-...

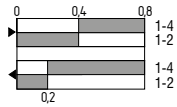

M 610-11-...-1E-...

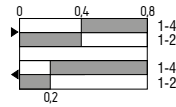

M 610-11-...-1D-...

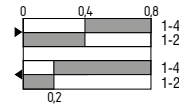



4. Micro switches

Series M 610 – Actuating elements



Telescopic plunger 2S

Actuator heads

Actuator description	Thermoplastic plunger
Actuating travel, total [mm]	2.50
Pre-travel [mm]	0.50
Max. differential [mm]	0.20
Actuating force [N]	2.10
Max. ejection force [N]	0.30

Switch travel diagrams

Snap action with self-cleaning contact

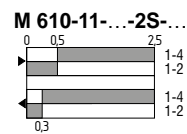

4. Micro switches

Series M 610 – Terminations



Soldering terminal with hole	Soldering terminal with collar	Screw terminals
 <ul style="list-style-type: none">■ Ordering suffix -20	 <ul style="list-style-type: none">■ Ordering suffix -21	 <ul style="list-style-type: none">■ Ordering suffix -60

4. Micro switches

Series M 630 – Actuating elements



Plunger



Actuator A

Actuator heads

Actuator description	Thermoplastic plunger	Lever can subsequently be realised in two lever bearings				
Actuating force [N]	1.2	See force-travel diagram on page 96				
Actuating travel [mm]	1.6	See force-travel diagram on page 96				
Actuators / Lever	-	A17	A24	A30	A40	A50
Length L1 [mm]	-	17	24	30	40	50
Total length L [mm]	-	20	27	33	43	53

Switch travel diagrams

Snap action
with double break

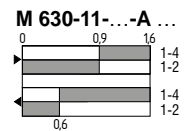
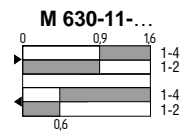



Actuator E



Actuator F

Plastic roller Ø 8 mm
Lever can subsequently be realised in two lever bearings

See force-travel diagram on page 96

See force-travel diagram on page 96

Plastic roller Ø 5 mm
Lever can subsequently be realised in two lever bearings

See force-travel diagram on page 96

See force-travel diagram on page 96

E17	E24	E30	E40	E50	F
17	24	30	40	50	16.2
20	27	33	43	53	18.2

M 630-11-...-E ...

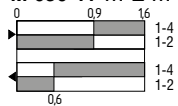

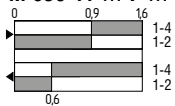

M 630-11-...-F ...





4. Micro switches

Series M 630 – Terminations and force-travel diagrams

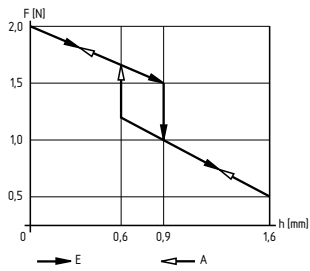
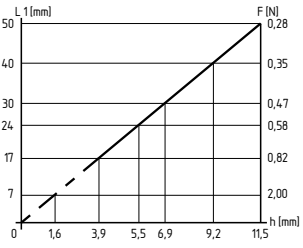
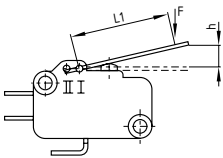
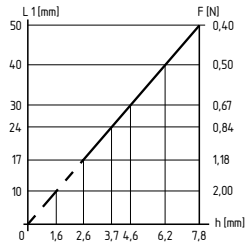
Soldering terminals	Plug-in connector	Universal terminal
 <ul style="list-style-type: none"> ■ Ordering suffix -2 	 <ul style="list-style-type: none"> ■ Ordering suffix -3 	 <ul style="list-style-type: none"> ■ Ordering suffix -5 ■ Universal terminal can be used as a soldering, plug-in or screw terminal
Force travel at plunger	Force travel at lever bearing I	Force travel at lever bearing II
 <p>Key</p> <ul style="list-style-type: none"> L1: Actuating distance h: Travel at actuator/plunger F: Actuating force at actuator/plunger E: Travel on depression of plunger A: Travel on return of plunger S: Switching point = $h / 1.78$ Δh: Differential = $h / 5.33$ 	 	

Proximity switches

Non-contact and electronic



Detailed information can be found in a separate catalogue
"Inductive Proximity switches"



4. Micro switches

Series M 6800 / 6900 – Actuating elements



Plunger

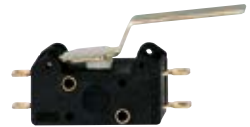

Actuator 80 A

Actuator heads

Actuator description	Thermoplastic plunger	
Actuating force	approx. 4 N	approx. 0.9 N
Actuating travel	2.2 mm	7.5 mm
Actuator weight	-	2.7 g

Switch travel diagrams

Snap action with self-cleaning contact

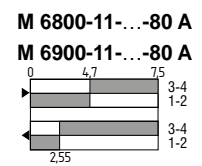
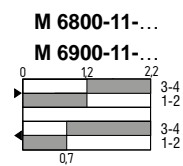

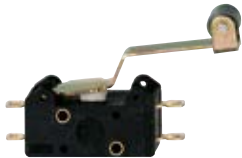

Actuator 80 E



Actuator 80 M



Actuator 80 B 9

Plastic roller Ø 8 mm

Stainless steel metal ball Ø 9 mm

approx. 0.95 N

approx. 2.4 N

approx. 3.8 N

7.5 mm

2.8 mm

2.2 mm

4 g

1 g

3.9 g

M 6800-11-...-80 A

M 6900-11-...-80 A

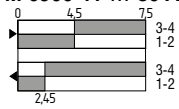

M 6800-11-...-80 A

M 6900-11-...-80 A

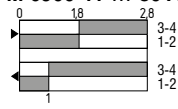

M 6800-11-...-80 A



M 6900-11-...-80 A



4. Micro switches

Series M 6800 / 6900 – Terminations

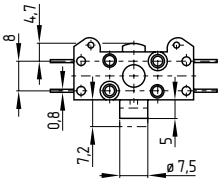
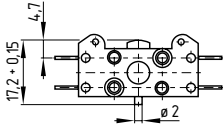

Soldering terminals	Flat plug-in connector	Universal terminal
 <ul style="list-style-type: none"> Ordering suffix -2 	 <ul style="list-style-type: none"> Ordering suffix -3 	 <ul style="list-style-type: none"> Ordering suffix -5
Latching in the limit positions	Tandem design	
 <ul style="list-style-type: none"> Ordering suffix -P2 	 <ul style="list-style-type: none"> Ordering suffix -P3 	

4. Micro switches



Series Z/T 232 – Actuating elements



Plunger

Actuator heads

Actuator description	Thermoplastic plunger
Actuating force	approx. 9 N
Actuating travel	6.0 mm

Switch travel diagrams

Snap action 1 NO / 1 NC	ZS 232-11
Slow action 1 NO / 1 NC	TS 232-11
2 NC	TS 232-02
2 NO	TS 232-20
1 NC	TS 232-01
1 NO	TS 232-10

4. Micro switches

Series M 687 and M/T 697 – Actuating elements



Plunger



Offset roller lever 8 R

Actuator heads

Actuator description	Thermoplastic plunger	Plastic roller Ø 8 mm Roller width 6.4 mm
Actuating force	approx. 4 N	approx. 4 N
Actuating travel	2.2 mm	6 mm

Switch travel diagrams

Snap action 1 NO / 1 NC	M 687-11-... M 697-11-...	M 687-11-...-8R-... M 697-11-...-8R-...
	T 697-01-...	T 697-01-...-8R-...

Accessories

Terminal cover

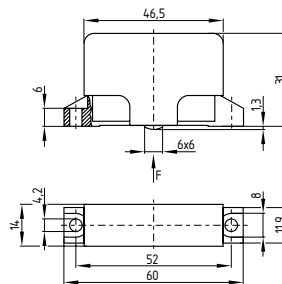

- Ordering suffix -i
- As protection against contact with live parts
- Hand and finger guard in accordance with VDE 0106-100
- Clips into position

4. Micro switches

Series Z/T 6881 – Actuating elements



Plunger

Offset roller lever 80R

Actuator heads

Actuator description	Thermoplastic plunger	Plastic roller Ø 8 mm Roller width 6.4 mm
Actuating force	Snap action: approx. 20 N; Slow action: approx. 7 N	Snap action: approx. 12 N; Slow action: approx. 4 N
Actuating travel	4.2 mm	6 mm

Switch travel diagrams

Snap action	1 NO / 1 NC	Z 6881-11-1-... 	Z 6881-11-1-80 R-...
Slow action	1 NO / 1 NC	T 6881-11-1-... 	T 6881-11-1-80 R-...

Accessories

Terminal cover

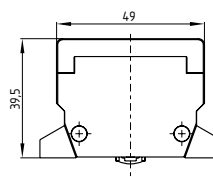

- Ordering suffix -i
- As protection against contact with live parts
- Hand and finger guard in accordance with VDE 0106-100
- Clips into position
- P7 with 4 mm extended plunger

4. Micro switches

Series M 660 / 6600 – Actuating elements



Basic component M

Semicircular rubber dome S

Actuator heads

Actuator description	Basic component M	Semicircular rubber dome S
Actuator description	Rubber enclosure Metal sheath: Stainless steel without mounting flange M 660, with mounting flange M 6600	Semicircular rubber dome Rubber enclosure Metal sheath: Stainless steel
Actuating force	2.5 N	-
Actuating travel	1.7 mm	3.5 mm
Actuating speed	-	-
Vertical actuating angle	-	-

Switch travel diagrams

Snap action with self-cleaning contact

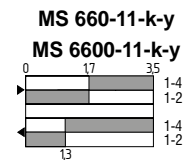
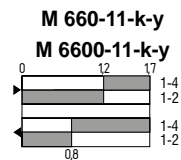



Telescopic plunger 1S

Telescopic plunger 2S

Roller telescopic plunger 2R

Threaded tube: nickel-plated brass
Simple mounting with steel hex nuts
Large after-travel
Excellent switching point setting options

Threaded tube: nickel-plated brass
Simple mounting with steel hex nuts
Large after-travel
Excellent switching point setting options
With bellows to protect the plunger from soiling

Threaded tube: nickel-plated brass
Simple mounting with steel hex nuts
Large after-travel
Excellent switching point setting options
with roller across the switch axis, ordering suffix -u

-
4 mm
-
-

-
6 mm
-
-

-
6 mm
max. 0.5 m/s
max. 30°

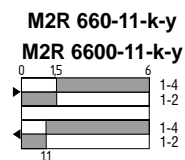
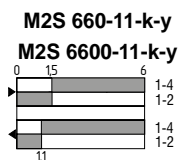
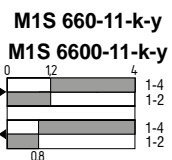

4. Micro switches

Series M 6610 / 6620 – Actuating elements



Semicircular rubber dome S



Telescopic plunger 1S

Actuator heads

Actuator description

Thermoplastic enclosure
without mounting flange M 6610,
with mounting flange M 6620

Simple mounting with
steel hex nuts
Large after-travel
Excellent switching point
setting options
With bellows to protect the plunger
from soiling

Actuating force

2.5 N

–

Actuating travel

2 mm

7 mm

Switch travel diagrams

Change-over contact with single break

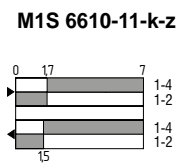
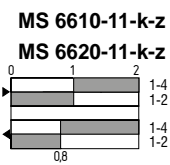



Telescopic plunger 2S

Roller telescopic plunger 2R

Simple mounting with steel hex nuts
 Large after-travel
 Excellent switching point setting options
 With bellows to protect the plunger from soiling

Simple mounting with steel hex nuts
 Large after-travel
 Excellent switching point setting options
 with roller across the switch axis, ordering suffix -u

-
 3.5 mm

-
 7 mm

M2S 6610-11-k-z

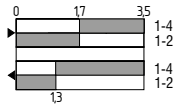

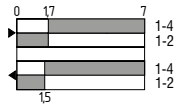

M2R 6610-11-k-z



4. Micro switches

Preferred types

Series		Connection	Actuator
M 610		Soldering terminal with hole	Actuator 1C Actuator 1E
		Soldering terminal with collar	Actuator 1A
		Screw terminals	Plunger Actuator 1A Actuator 1C
			Actuator 1E
M 630		Soldering terminals	Plunger Actuator F
		Plug-in connector	Actuator E17 Actuator E24
		Universal terminal	Plunger Actuator E17
M 6800		Flat plug-in connector	Actuator 80B9
M 6900		Soldering terminals	Actuator 80B9
		Flat plug-in connector	Plunger Actuator 80A Actuator 80B9
M 687		Screw terminals	Plunger
		Flat plug-in connector	Offset roller lever 8R Offset roller lever 8R
M/T 697		Screw terminals	Plunger Offset roller lever 8R
Z/T 6881		Screw terminals	Plunger Offset roller lever 80R
Z/T 232		Screw terminals	Plunger S
M 660/6600		Connecting cable 3 x 0.75 mm ²	Basic component M Telescopic plunger 1S Telescopic plunger 2S Roller telescopic plunger 2R Basic component M Rubber dome S Telescopic plunger 1S Telescopic plunger 2S Roller telescopic plunger 2R
M 6610/6620		Connecting cable 3 x 0.75 mm ²	Roller telescopic plunger 2R Telescopic plunger 2S Telescopic plunger 1S Rubber dome S

	Lever bearing	Special features	Type designation	Part number
	II	---	M 610-11-20-1C	101061367
	II	---	M 610-11-20-1E	101061368
	III	---	M 610-11-20-1E-III	101103324
	III	---	M 610-11-21-1A-III	101087693
	---	---	M 610-11-60	101088335
	III	---	M 610-11-60-1A-III	101091701
	II	---	M 610-11-60-1C	101061406
	II	---	M 610-11-60-1E	101061408
	III	---	M 610-11-60-1E-III	101089809
	---	---	M 630-11-2	101061417
	---	Magnetic arc quenching	M 630-11-2-C	101061418
	II	---	M 630-11-2-F-II	101087707
	II	---	M 630-11-3-E17-II	101088373
	I	---	M 630-11-3-E24	101061483
	---	---	M 630-11-5	101061493
	---	Magnetic arc quenching	M 630-11-5-C	101061494
	I	Magnetic arc quenching	M 630-11-5-C-E17	101061518
	---	Tandem design	M 6800-11-3-P3-80B9	101061884
	---	---	M 6900-11-2-80B9	101061897
	---	Latching in the limit positions	M 6900-11-3-P2	101061926
	---	---	M 6900-11-3-80A	101061903
	---	---	M 6900-11-3-80B9	101061904
	---	Tandem design	M 6900-11-3-P3-80B9	101061947
	---	---	M 687-11-1	101055253
	---	Gold contacts	M 687-11-1-AUNI	101055255
	---	---	M 687-11-1-8R	101055284
	---	---	M 687-11-3-8R	101055281
	---	Snap action	M 697-11-1	101055182
	---	Slow action	T 697-01-1	101055452
	---	Snap action	M 697-11-1-8R	101055185
	---	Slow action	T 6881-11-1	101138614
	---	Snap action	Z 6881-11-1	101138616
	---	Slow action	T 6881-11-1-80R	101138615
	---	Snap action	Z 6881-11-1-80R	101138617
	Snap action	1 NO / 1 NC	ZS 232-11	101113330
		2 NC	ZS 232-02	101113332
	Slow action	1 NO / 1 NC	TS 232-11	101113333
		1 NO / 1 NC	TS 232-11UE	101181513
		2 NC	TS 232-02	101113335
		2 NO	TS 232-20	101113334
	---	---	M 660-11-K-Y	101055325
	---	---	M1S 660-11-K-Y	101055425
	---	---	M2S 660-11-K-Y	101055373
	---	---	M2R 660-11-K-Y	101055396
	---	with mounting flange	M 6600-11-K-Y	101055341
	---	with mounting flange	MS 6600-11-K-Y	101055354
	---	with mounting flange	M1S 6600-11-K-Y	101055442
	---	with mounting flange	M2S 6600-11-K-Y	101055391
	---	with mounting flange	M2R 6600-11-K-Y	101055418
	Roller across the switch axis	with mounting flange	M2R 6600-11-K-Y-U	101086952
	---	---	M2R 6610-11-K-Z	101055457
	---	---	M2S 6610-11-K-Z	101055456
	---	---	M1S 6610-11-K-Z	101055455
	with mounting flange	---	MS 6620-11-K-Z	101055458

5. Magnetic reed switches

Description

Magnetic reed switches

Alongside mechanically operated limit switches, magnetic reed switches are enjoying an increase in importance. They are often used to complement limit switches with plungers, rollers and swivel levers and are considered an important link to non-contact and contactless limit switches.

Non-contact limit switches are ideally used where mechanically operated limit switches cannot function as they ideally should, due to unfavourable operating conditions such as:

- High or low operating speeds
- High or low switching frequency
- Strong influence of dirt and dust
- High humidity
- Chemical atmospheres
- Large fluctuations in actuating pre-travel





One type of non-contact limit switch is the magnetic reed switch (other types: inductive, capacitive and optical proximity switches, see series I).

In order to select the right switch, however, it is important to familiarise yourself with the general design, function, benefits and drawbacks of magnetic reed switches.

Magnetic reed switches of type series BN 2, BN 3, BN 6 and BN 8 comprises two units – the switch itself and the actuating magnet.

The switching tubes in our magnetic reed switches are filled with inert gas (nitrogen). The contact reeds, which are made from iron/nickel alloy, are melted into a glass body and coated with rhodium around the contact points. The gap between the contact reeds is just 0.2 - 0.3 mm, so that the magnetic force required for the switching process is minimal. The enclosed glass body keeps the contact points clean of dust, moisture and corrosion, helping to increase the contact reliability of magnetic reed switches to an extremely high level.

The design and precise calculation of the pre-loaded magnet determines the contact type:

	NO contact
	NC contact
	Toggle contact
	Bistable contact
	Bistable toggle contact



Permanent magnets

Both permanent magnets (with/without enclosure) and electromagnets are used for switch actuation. The switching magnet selected for side actuation is dependent on the switch type. For NC, NO and toggle contacts, this is a switching magnet with N-S pole; for bistable and bistable toggle contacts, this is a switching magnet with N-pole or S-pole.

The barium ferrite used as the magnet material in our permanent magnets is both resistant to ageing and resistant to external magnetic fields, which could impair its magnetic strength. Its temperature sensitivity of 0.2%/ °C with respect to switching point accuracy should, however, be borne in mind, as magnetic force will decrease by this factor as temperatures rise, and increase as temperatures fall. A permanent change in the -30 °C to +90 °C range is not to be expected.

Magnetic field, N-S magnet

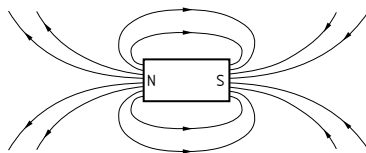

Magnetic field, N-magnet or S-magnet

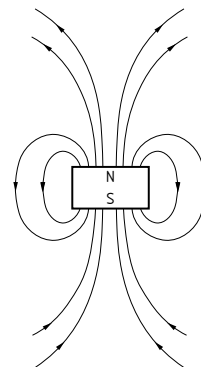

5. Magnetic reed switches

Description

Front side actuation

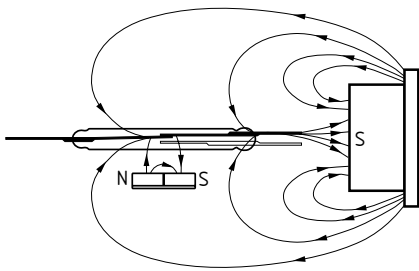

Front side actuation

To actuate the magnetic reed switches from the side with a magnet in the manner outlined above, some type series can be actuated from the side or front side (index V).

Switches with NO, NC and toggle contact types are actuated from the side with an N-S magnet, as is customary. All switches are marked in the same place with symbols to ensure the correct pairing and actuation direction of the switching magnets. The following applies: S/green to S/green and N/red to N/red.

Front side actuation for NO, NC and toggle contact types is only possible with S-poled magnets. A red symbol plate with direction arrows is mounted to the front.

Switches with bistable and bistable toggle contact types are actuated from the side with either an N-pole or S-pole magnet, depending on the function, as is customary. In this case too, coloured symbols are mounted to the side of the switch to indicate the actuation direction.

Front side actuation for bistable and bistable toggle contacts can only be effected in the direction specified on the front symbol plate with an N-S magnet. If the N-S magnet is rotated 180° around the magnet's axis, the bistability changes to the opposite direction.

Resistance to vibration

Although the bistable switch requires a considerable setting accuracy when compared to NO and NC switches, these devices are extremely resistant to vibration. By embedding the switching tube troughs in foam rubber, the BN 20 type series has increased vibration strength. If the switches are under the influence of the switching magnets, even strong vibrations will not be capable of altering the switching condition. Caution should always be exercised when it comes to heavy shock loads, as too high a load can render a magnetic reed switch non-functional, irrespective of the contact type, due to permanent deformation of the contact reeds.

Life

It must be ensured that carefully harmonised devices are not damaged due to overload when being installed or tested.

Magnetic switch contacts have a tendency to stick if the maximum specified current strength is exceeded. Once re-opened, they continue to function, but lose accuracy, potentially turning a NC contact into a NO contact. If lamps or alternating current magnets are switched on, the current peaks that occur at the point of switch-on may be ten to twelve times the rated current. When switching off inductive circuits, excess voltages occur, which can quickly lead to complete destruction of devices. In such cases, it is essential that suitable spark suppression measures are introduced. In order to minimise excess voltages, VDR resistors may be switched in parallel with the inductive circuits.

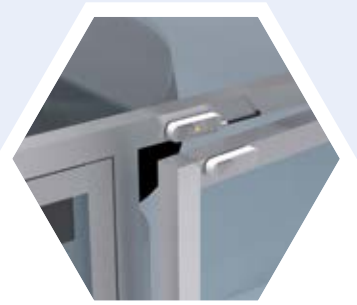

Usual spark suppression with capacitors always involves use of a damping resistor, as otherwise there is a risk of welding from the charge and discharge processes of the capacitor. The optimum values for means of suppression (RC circuit) can, however, only be determined by means of tests on a case-by-case basis. It should be noted that incorrect adjustment may be more disadvantageous than no adjustment at all. In DC current circuits, we recommend switching a diode in parallel to the inductive circuit to help protect the contacts.

If magnetic reed switches are protected from overloads as outlined above, the life of an electrical contact may far exceed that of the device being switched. Non-contact switches actuated with minimal force are also exposed to no wear on the drive side, giving them an almost unlimited life.

Switching hysteresis

Like mechanical snap-action switches, magnetic reed switches have a switching hysteresis, i.e. their switch-on and switch-off points do not coincide. This particular property is the result of the difference in response and drop-out excitation. Since this difference is also a measure of the contact pressure, and therefore the contact reliability, an ideal value of 0, i.e. switch-on and switch-off at the same point, cannot be achieved.

Uses

Magnetic reed switches can be used in virtually all areas of control technology, and owing to their special characteristics, are often preferred over mechanically operated limit switches.

Some examples are:

1. High switching speed and large switching frequency: use in counting circuits.
2. Reliable contacting, even in the presence of aggressive media, as the contact point is located inside a protective tube: use in galvanic equipment.
3. No mechanical drives, low actuating force: use in motion sensors and standstill monitoring.
4. Low noise: use in lift construction.
5. Non-contact actuation, operated with non-magnetic materials: use as pressure monitors and float switches.

5. Magnetic reed switches

Overview of the series



■ BN 80



■ BN 85 ¹⁾



■ BN 310

Key Features

Switching distance max.	60 mm	40 mm	60 mm
Contact variants	Bistable contact NC/NO	Bistable contact	Bistable contact NC/NO
Actuation direction	From side	front side	side or front available on request
Design	rectangular, flat	rectangular	rectangular, flat

Technical features

Electrical characteristics			
Switching voltage	250 VAC/DC	60 VAC/DC	250 VAC/DC
Switching current	0.5 A	1 A	3 A
Switching capacity	10 VA / 8 W	30 VA / W	120 VA / W
Resistance to shock	15 g, on sine wave oscillation	60 g, on sine wave oscillation	30 g / 11 ms
Mechanical data			
Housing material	Thermoplastic enclosure	Thermoplastic enclosure	Thermoplastic enclosure
Connection	LiYY cable, 1 m	2 single conductors LiY, 1 m	Cable H03VV-F
Cable section:	2 x 0.25 mm ²	2 x 0.75 mm ²	2 x 0.75 mm ²
Dimensions (W x D x H)	44 x 13 x 9 mm	40 x 35 x 16.5 mm	88 x 25 x 13 mm
Ambient conditions			
Ambient temperature	-25 °C ... +75 °C	0 °C ... +75 °C	-25 °C ... +75 °C
Protection class	IP67	IP40	IP67
Actuator heads	refer to page 120	refer to page 120	refer to page 120

Safety classification

Certificates



(Exception: Index -R)

-



To get detailed information about the products and certificates, visit www.schmersal.net.



■ BN 325 ²⁾



■ BN 20



■ BN 75



■ BN 120



■ BN 650

55 mm	50 mm	-	60 mm	60 mm
Bistable contact From side	Bistable contact NC/NO side or front	NC, NO Float switch	Bistable contact NC/NO side or front	Bistable contact NC/NO side or front
rectangular	rectangular	-	cylindrical, Ø 12 mm	cylindrical, Ø 13 mm
250 VAC/DC 3 A 120 VA / W 50 g / 11 ms	250 VAC/DC 3 A 120 VA / W -	220 VAC/DC 1 A 60 VA / W -	200 VAC/DC 1 A 30 VA / W 30 g / 11 ms	200 VAC/DC 1 A 30 VA / W 30 g / 11 ms
Thermoplastic enclosure Various terminations, see table on page 116	Metal enclosure Screw terminals	Thermoplastic enclosure M12 connector or pre-wired cable	Thermoplastic enclosure LiYY cable, 1 m	Thermoplastic enclosure LiYY cable, 1 m
-	-	-	2 x 0.25 mm ²	2 x 0.25 mm ²
85 x 26 x 24 mm	104 x 52 x 47 mm	80 x 99.5 x 55 mm	Ø12, 71 mm	Ø13, 103 mm
-25 °C ... +75 °C	-25 °C ... +90 °C	-25 °C ... +80 °C	-25 °C ... +70 °C	-25 °C ... +70 °C
IP40 / IP67	IP67	IP68, IP65 (connector) IP67 (cable)	IP67	IP67
refer to page 120	refer to page 120	refer to page 120	refer to page 120	refer to page 120
-	-	-	-	-

¹⁾ The magnetic switch BN 85-5 enables installing up to 5 BN 85 units in one enclosure.

Mutual interference can be avoided due to integrated shielded plates.

²⁾ Because of its integrated shield and plug connector, BN 325 is especially suitable for installations close together.

Protection class: IP40 with insulated plug, IP67 with cable outlet on additional shielding plate.

5. Magnetic reed switches

Preferred types

Series	Actuation	Connection	Switching distance	Contacts	Latching	Type designation	Material number	
BN 80	From side	pre-assembled cable, 1m	20 mm	1NC		BN 80-01Z	101082364	
			32 mm	1NO		BN 80-10Z	101055844	
			60 mm	1 bistable contact	■	BN 80-RZ	101139647	
BN 310	From side	pre-assembled cable, 1m	20 mm	1NO/1NC contact	■	BN 310-11RZ	101184486	
				2NC		BN 310-2RZ	101182138	
			50 mm	1NC		BN 310-01Z	101133844	
			60 mm	1NO		BN 310-10Z	101133842	
			60 mm	1 bistable contact	■	BN 310-RZ	101133843	
BN 325	Front side	Blade terminal 4.8 mm and 1 shielding plate	55 mm	1 bistable contact	■	BN 325-R	101147009	
		Blade terminal 4.8 mm and 2 shielding plates				BN 325-R-1239	101147090	
		Cable outlet left and 2 shielding plates				BN 325-R-1279	101147091	
		Cable outlet right and 2 shielding plates				BN 325-R-1279-2	101148084	
BN 20	From side	---	45 mm	1NC		BN 20-01Z	101172087	
				2NC		BN 20-02Z	101057005	
				1NO		BN 20-10Z	101172882	
				1NO/1NC		BN 20-11Z	101168014	
	From side	---	50 mm	2NO		BN 20-20Z	101057006	
				1NO/1NC	■	BN 20-11RZ	101165310	
				2 bistable contact		BN 20-2RZ	101172893	
				1 bistable contact		BN 20-RZ	101168090	
1 bistable contact	BN 20-RZ-ST	101155508						
BN 75	Float switch	---	---	1NC		BN 75-01Y	101055740	
				1NC		BN 75-01Z-1391	101055741	
				1NO		BN 75-10Y	101055743	
				1NO		BN 75-10Z-1391	101055744	
				1NO/1NC		BN 75-11Y	101055701	
				1NO/1NC		BN 75-11Z-1391	101055702	
BN 120	From side	Threaded flange M12	50 mm	1NC		BN 120-01Z	101186840	
			60 mm	1NO		BN 120-10Z	101186839	
	Front side		45 mm	1 bistable contact	■	BN 120-RZ	101186843	
			55 mm	1NC		BN 120-RZ/V	101186844	
				1NO		BN 120-01Z/V	101186842	
			55 mm	1NO		BN 120-10Z/V	101186841	
BN 650	From side	pre-assembled cable, 1m	50 mm	1NC		BN 650-01Z	101187280	
			60 mm	1NO		BN 650-10Z	101187273	
	Front side		45 mm	1 bistable contact	■	BN 650-RZ	101187283	
				55 mm	1NC		BN 650-RZ/V	101187284
					1NO		BN 650-01Z/V	101187282
			55 mm	1NO		BN 650-10Z/V	101187281	

5. Magnetic reed switches

Ordering code

BN 120-10Z/V

Enclosure selection

80	rectangular, flat
310	rectangular, flat
325	rectangular
20	rectangular
75	Float switch
120	cylindrical, Ø 12 mm
650	cylindrical, Ø 13 mm

Contacts

01	1 NC
02	2 NC
10	1 NO
11	1 NO/1 NC
20	2 NO
R	1 bistable contact
2R	2 bistable contact

Termination on BN325

	Blade terminal 4.8 mm and 1 shielding plate
1239	Blade terminal 4.8 mm and 2 shielding plates
1279	Cable outlet left and 2 shielding plates
1279-2	Cable outlet right and 2 shielding plates

Actuation direction

	From side
V	front side

For technical reasons not all possible variations and/or combinations can be delivered.
The existing key type is used to translate the product type designation.

To see a wide range of other types, visit www.schmersal.net.

5. Magnetic reed switches

Selection of actuating magnets according to switch distances

Actuating magnet	BN 80			BN 85-r	BN 310	BN 310 with bistable contact		BN 325-r
	BN 80-10z	BN 80-01z	BN 80-rz			BN 310-rz	BN 310-2rz	
BP 6 S			4 - 18	2 - 12				
BP 7 S			6 - 22					
BP 8	3 - 8	0 - 5						
BP 8 S				2 - 10				
BP 10	6 - 12	2 - 9	2 - 9		5			
BP 10 N						15		10
BP 10 S			10 - 30	5 - 20		15		10
2 x BP 10	12 - 20	2 - 13	2 - 13		17			
2 x BP 10 N						20		15
2 x BP 10 S			12 - 36	6 - 27		20		15
BP 15	8 - 14	2 - 10			6			
BP 15 N								
BP 15 S								
2 x BP 15	12 - 22	2 - 15			17			
2 x BP 15S			13 - 38	7 - 28				
2 x BP 15/2					17			
2 x BP 15/2 N						22		17
2 x BP 15/2 S						22		17
BP 34					5 - 20			
BP 34 N						15 - 30		10 - 25
BP 34 S			20 - 50	10 - 40		15 - 30		10 - 25
2 x BP 34	12 - 26	5 - 18						
2 x BP 34 S			22 - 60					
BP 20	12 - 24	0 - 14			20			
BP 20 N						3 - 25		5 - 20
BP 20 S			10 - 38	3 - 28		3 - 25		5 - 20
BP 31	12 - 24	0 - 14			20			
BP 31 N						3 - 25		5 - 20
BP 31 S			12 - 40	4 - 30		3 - 25		5 - 20
BP 11								
BP 11 N						15		10
BP 11 S			10 - 30	4 - 23		15		10
2 x BP 11 N								
2 x BP 11 S								
BP 12	24 - 32	4 - 20			10 - 30			
BP 12 N						20		15
BP 12 S			10 - 34	5 - 27		20		15
2 x BP 12 N								
2 x BP 12 S								
BP 21								
BP 21 N						15 - 45		15 - 40
BP 21 S						15 - 45		15 - 40
2 x BP 21 N								
2 x BP 21 S								
BP 22 N								
BP 22 S								
2 x BP 22 N								
2 x BP 22 S								
BP 310-1S							0 - 10	
BP 310-1N							0 - 10	
BP 310-2S							0 - 15	
BP 310-2N							0 - 15	
BE 20					20			
BE 20 N						20		15
BE 20 S						20		15

The specified switching distances are applicable for the actuation of individually mounted components without ferromagnetic influence. A change to the distance, positive or negative, is possible due to ferromagnetic influences.

BN 20		BN 120		BN 120-../V		BN 650		BN 650-../V	
	with bistable contact		with bistable contact		with bistable contact		with bistable contact		with bistable contact
		5				5			
	5		15				15		
	5		15	5			15	5	
12		17			3	17			3
	10		20				20		
	10		20	10			20	10	
		6				6			
			17				17		
			17	6			17	6	
		17				17			
12		17				17			
	15		22				22		
	15		22				22		
		15 - 20			15	15 - 20			15
	10 - 25		15 - 30				10 - 30		
	10 - 25		15 - 30	20			15 - 30	20	
15		20			10	20			10
	15		25				25		
	15		25	15			25	15	
15		20			10	20			10
	15		25				25		
	15		25	15			25	15	
		20			15	20			15
	5		15				15		
	5		15	5			15	5	
			25				25		
			25	15			25	15	
25		10 - 30			20	10 - 30			20
	10		20				20		
	10		20	10			20	10	
			10 - 30				10 - 30		
			10 - 30	25			10 - 30	25	
		25 - 50			45	25 - 50			45
	10 - 35		15 - 45				15 - 45		
	10 - 35		15 - 45	30			15 - 45	30	
			20 - 60				20 - 60		
			20 - 60	20 - 55			20 - 60	20 - 55	
									35
				25				25	35
					35				
				15 - 55	35			15 - 55	
15					10				10
	10		20				20		
	10		20	6			20	6	

The mutual interference between multiple actuating magnets must be observed. (For special versions: diverging values possible)

5. Magnetic reed switches

Actuating magnets

BP 6 101091837	BP 7 101125556	BP 8 101054816
 <ul style="list-style-type: none"> ■ Actuating magnet, unenclosed, N-S ■ S pole: 90° lowered 	 <ul style="list-style-type: none"> ■ Actuating magnet, unenclosed, N-S ■ S-pole marked red 	 <ul style="list-style-type: none"> ■ Actuating magnet, unenclosed, N-S ■ S-pole marked red
BP 10 101057531	BP 11 N 101059923	BP 11 S 101057533
 <ul style="list-style-type: none"> ■ Actuating magnet, unenclosed, N-S ■ Colour coding of poles by labels 	 <ul style="list-style-type: none"> ■ Actuating magnet, metal enclosure Al, N ■ N-pole marked green ■ For mounting on ferrous material 	 <ul style="list-style-type: none"> ■ Actuating magnet, metal enclosure Al, S ■ S-pole marked red ■ For mounting on ferrous material
BP 12 N 101059917	BP 12 S 101057532	BP 15 SS 101139818
 <ul style="list-style-type: none"> ■ Actuating magnet, metal enclosure Al, N ■ N-pole marked green ■ For mounting on ferrous material 	 <ul style="list-style-type: none"> ■ Actuating magnet, metal enclosure Al, S ■ S-pole marked red ■ For mounting on ferrous material 	 <ul style="list-style-type: none"> ■ Actuating magnet, N-S ■ Stainless steel ■ Suitable for food processing industry

5. Magnetic reed switches

Actuating magnets

<p>BP 15 101060163</p>  <ul style="list-style-type: none"> ■ Actuating magnet, with plastic enclosure, N-S ■ S-pole marked red ■ N-pole marked green ■ Suitable for mounting on ferrous material with a distance of 18 mm 	<p>BP 34 101057553</p>  <ul style="list-style-type: none"> ■ Actuating magnet, with plastic enclosure, N-S ■ S-pole marked red ■ N-pole marked green ■ Suitable for mounting on ferrous material with a distance of 25 mm 	<p>BP 34/2 101195164</p>  <ul style="list-style-type: none"> ■ Actuating magnet, unenclosed, N-S ■ S-pole marked red
<p>BP 15/2 101060165</p>  <ul style="list-style-type: none"> ■ Actuating magnet, unenclosed, N-S ■ Polarity pressed ■ Suitable for mounting on ferrous material with a distance of 18 mm 	<p>BP 21 N 101057536</p>  <ul style="list-style-type: none"> ■ Actuating magnet, metal enclosure Al, N ■ N-pole marked green ■ For mounting on ferrous material 	<p>BP 21 S 101057534</p>  <ul style="list-style-type: none"> ■ Actuating magnet, metal enclosure Al, S ■ S-pole marked red ■ For mounting on ferrous material
<p>BP 20 101057549</p>  <ul style="list-style-type: none"> ■ Actuating magnet, metal enclosure Al, S ■ S-pole marked red ■ N-pole marked green ■ Suitable for mounting on ferrous material with a distance of 20 mm 	<p>BP 20 N 101057538</p>  <ul style="list-style-type: none"> ■ Actuating magnet, metal enclosure Al, N ■ N-pole marked green ■ Suitable for mounting on ferrous material with a distance of 20 mm 	<p>BP 20 S 101057541</p>  <ul style="list-style-type: none"> ■ Actuating magnet, metal enclosure Al, S ■ S-pole marked red ■ Suitable for mounting on ferrous material with a distance of 20 mm

5. Magnetic reed switches

Actuating magnets

BP 22 N(S) 101057432	BP 22/2 N(S) 101057544	BP 31 101057530
 <ul style="list-style-type: none"> ■ Actuating magnet; Zn metal enclosure ■ S-pole marked red ■ N-pole marked green ■ For mounting on ferrous material ■ Can be used as N or S magnet 	 <ul style="list-style-type: none"> ■ Actuating magnet; Zn metal enclosure ■ S-pole marked red, N-pole marked green ■ 33 % magnetic force ■ For mounting on ferrous material ■ Can be used as N or S magnet 	 <ul style="list-style-type: none"> ■ Actuating magnet, with plastic enclosure, N-S ■ S-pole marked red ■ N-pole marked green ■ Suitable for mounting on ferrous material with a distance of 20 mm
BP 31 N 101057520	BP 31 S 101057521	BP 310-1 N 101182160
 <ul style="list-style-type: none"> ■ Actuating magnet, with plastic enclosure, N-S ■ N-pole marked green ■ Suitable for mounting on ferrous material with a distance of 20 mm 	 <ul style="list-style-type: none"> ■ Actuating magnet, with plastic enclosure, S ■ S-pole marked red ■ Suitable for mounting on ferrous material with a distance of 20 mm 	 <ul style="list-style-type: none"> ■ Actuating magnet, with plastic enclosure, N-S ■ Switching distance 0 ... 10 mm
BP 310-1 S 101182275	BP 310-2 N 101182284	BP 310-2 S 101182287
 <ul style="list-style-type: none"> ■ Actuating magnet, with plastic enclosure, S ■ Switching distance 0 ... 10 mm 	 <ul style="list-style-type: none"> ■ Actuating magnet, with plastic enclosure, N-S ■ Switching distance 0 ... 15 mm 	 <ul style="list-style-type: none"> ■ Actuating magnet, with plastic enclosure, S ■ Switching distance 0 ... 15 mm

5. Magnetic reed switches

Actuating magnets/Accessories

BE 20 24V 101057437	HOLDER H1/1 101068965	HOLDER H2 101068281
 <ul style="list-style-type: none"> ■ Electromagnet, with plastic enclosure 	 <ul style="list-style-type: none"> ■ For BN 650 ■ Metal holder with 2 elasticated bearing blocks ■ Guarantees high vibration resistance 	 <ul style="list-style-type: none"> ■ For BN 650 ■ Metal holder with rubber discs
CLAMP H 15 101068881	COMPENSATION COIL KS 1 101064997	COMPENSATION COIL KS 2 101065000
 <ul style="list-style-type: none"> ■ For BN 650 ■ Material: thermoplastic 	 <ul style="list-style-type: none"> ■ Temperature range $-25\text{ °C} \dots +90\text{ °C}$ ■ For cable lengths up to 100 m ■ Connecting cable H05V-K 1 mm², Cable length 100 mm ■ Position compensation coil in series with switching pipe ■ Temperature-resistant design -25 °C to $+150\text{ °C}$, ordering suffix -T 	 <ul style="list-style-type: none"> ■ Temperature range $-25\text{ °C} \dots +90\text{ °C}$ ■ For cable lengths up to 200 m or 2 x 100 m ■ Connecting cable H05V-K 1 mm², Cable length 100 mm ■ Position compensation coil in series with switching pipe

6. Pull-wire switches

Description

Area of application

Pull-wire switches are used on machinery and plants for signalling and/or for area monitoring. The switching command can be activated at arbitrary points on the wire run.

Areas of application range from issuing commands in a production process, to machinery startup and opening/closing electrically operated doors and gates.

Design and way of functioning

The way of functioning is dependent on the application and the type of pull-wire switch that has been selected.

Types with wire pull and wire breakage detection require the wire to be pre-tensioned so that the pull-wire switch is in the switching condition. The switching function is activated if the tensioned pull wire is pulled or in the event of wire breakage. In this case, the normally-closed contacts are opened and the normally-open contacts are closed.

On types with wire pull function, the switching function is activated by a quick pull on the wire. In this case, the pull-wire switch must be fitted vertically. Types with varying pulling forces are available, depending on the application.

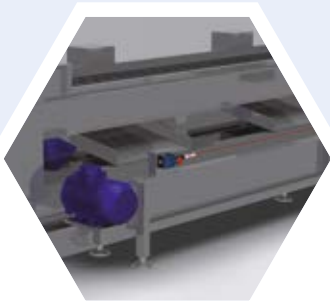

Mounting instructions

Pull-wire switch with wire pull and wire breakage detection - TQ 700/TQ 900/TQ 441

If the tensioned pull wire is pulled or in the event of wire breakage, the switching function of the pull-wire switch is activated.

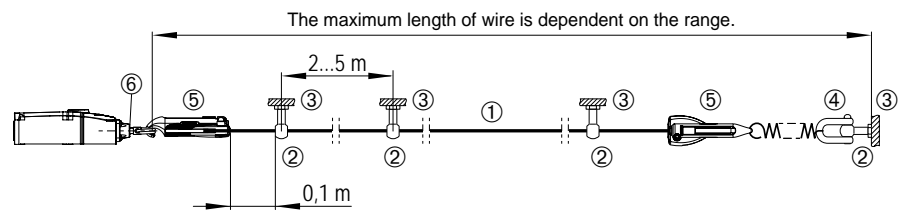

Pull-wire switch with wire pull function - TQ 700 S

The TQ 700 S pull-wire switch must be fitted vertically.

If the pull-wire is pulled, the switching function of the pull-wire switch is activated.

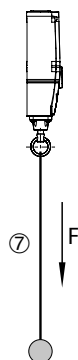

Key

- ① Wire rope
- ② Eyebolt
- ③ nut
- ④ shackle
- ⑤ Rope tensioner
- ⑥ Position indication
- ⑦ Pull wire with sphere (accessories available)

6. Pull-wire switches

Overview of the series



■ TQ 700 S



■ TQ 700

Key Features

- Wire pull detection
- Maximum cable length 10 m
- 2 contacts

- Wire pull and breakage detection
- Maximum cable length 10 m
- 2 contacts

Technical features

Electrical characteristics		
Max. switching capacity U/I	230 VAC / 4 A; 24 VDC / 4 A	230 VAC / 4 A; 24 VDC / 4 A
Mechanical data		
Actuating force	88 N (40 N)	17 N
Cable entry	1 x M20	1 x M20
Cable section ¹⁾	0.75 ... 2.5 mm ²	0.75 ... 2.5 mm ²
Dimensions (W x H x D)	40.5 x 160 x 51 mm	40.5 x 160 x 51 mm
Ambient conditions		
Ambient temperature	-25 °C ... +70 °C	-25 °C ... +70 °C
Protection class	IP67	IP67

Safety classification

Approvals



¹⁾ Including conductor ferrules



To get detailed information about the products and certificates, visit www.schmersal.net.



■ TQ 900



■ TQ 441

- Wire pull and breakage detection
- Maximum cable length 75 m
- 4 contacts

- Wire pull and breakage detection
- Maximum cable length 25 m
- 2 contacts

230 VAC / 4 A;
24 VDC / 1 A

230 VAC / 4 A;
24 VDC / 4 A

42 N

17 N (4 N)

3 x M20

2 x M20

0.75 ... 2.5 mm²

0.75 ... 4 mm²

71 x 220 x 69.7 mm

106 x 135 x 61 mm

-25 °C ... +70 °C
IP67





-30 °C ... +90 °C
IP65



6. Pull-wire switches

Preferred types



Series	Enclosure	Operating principle	Possible wire length	Wire pull/wire breakage detection	Contacts	Special equipment	Type designation	Material number		
TQ 700		Thermoplastic	1-side operation	10 m	■	1 NO/1 NC		TQ 700-11	101192479	
					■	2NC		TQ 700-02	101192480	
					■	2NO		TQ 700-20	101192481	
TQ 700 S		Thermoplastic	1-side operation	10 m	Wire pull detection		1 NO/1 NC		TQ 700-11 S	101217092
							1 NO/1 NC	Reduced actuating force	TQ 700-11S-40N	103003622
							2NC		TQ 700-02 S	101217791
							2NO		TQ 700-20 S	103000084
TQ 900		Zinc die-cast/ thermoplastic	1-side operation	75 m	■	1 NO/1 NC	Indicator lamp see accessories	TQ 900-11	101184478	
					■	2 NO/2 NC		TQ 900-22	101184479	
					■	1 NO/3 NC		TQ 900-13	101184481	
					■	2NC		TQ 900-02	101186145	
TQ 441		Die-cast aluminium	1-side operation	25 m	■	1NC / 1NC		TQ 441-01/01Y-UE	101160101	
					■	1NC / 1NC	Reduced actuating force	TQ 441-01/01Y-UE-1572	101062344	

Other versions upon request.

To see a wide range of other types of pull-wire switch, visit www.schmersal.net.

6. Pull-wire switches

Accessories



<p>Eyebolt</p>  <ul style="list-style-type: none"> ■ BM 10 x 40 101084928 ■ BM 8 x 70 Niro 101192471 ■ Included in delivery: Eyebolt with nut 	<p>Wire clamp</p>  <ul style="list-style-type: none"> ■ Wire clamp ■ 3 mm Niro 101203477 ■ 5 mm Niro 101203478 	<p>Duplex wire clamp 101190917</p>  <ul style="list-style-type: none"> ■ Duplex wire clamp 3 mm (stainless steel)
<p>Egg-shaped wire clamp 101196043</p>  <ul style="list-style-type: none"> ■ Egg-shaped wire clamp, size 3 	<p>Wire thimbles</p>  <ul style="list-style-type: none"> ■ Wire thimble ■ 3 mm Niro 101203472 ■ 5 mm Niro 101203476 	<p>Pulley 101192433</p>  <ul style="list-style-type: none"> ■ Pulley (stainless steel) to guide the wire rope where the path is not a straight line ■ According to ISO 13850, pulleys may only be mounted in such a way that the complete length of the pull-wire is visible.
<p>Tensioning jack 101087930</p>  <ul style="list-style-type: none"> ■ Tensioner M6 ■ For exact adjustment of the tension of the wire rope ■ Adjustable 145 mm ... 225 mm ■ To DIN 1480 	<p>Tension spring</p>  <ul style="list-style-type: none"> ■ Tension spring to maintain the reaction force ■ RZ-2041 (only for TQ 900) 101186696 ■ ACC-700-RZ173I (only for TQ 700) 103005863 	<p>Shackle 101186490</p>  <ul style="list-style-type: none"> ■ Shackle (stainless steel) ■ For fixing the wire rope to the eyebolt

For detailed information on selection, visit www.schmersal.net.

6. Pull-wire switches Accessories



Wire rope	Wire unit complete	S 900 rope tensioner	101186704
 <ul style="list-style-type: none"> ■ Wire rope ■ With red PVC sheath ■ Ø total 5 mm ■ Ø of the steel core 3 mm <p style="text-align: right;">on request</p>	 <ul style="list-style-type: none"> ■ Wire unit complete ■ Ready-to-fit ■ Included in delivery: 1 Wire rope; 2 Wire clamps; 1 Duplex wire clamp; 1 Wire thimble; 1 Eyebolt <p style="text-align: right;">on request</p>	 <ul style="list-style-type: none"> ■ S 900 rope tensioner ■ Straightforward, time-saving wire tension setting 	
Cable gland	Cable gland	Screw plug	103006011
 <ul style="list-style-type: none"> ■ M20 x 1,5 cable gland, metal ■ For TQ 900 / TQ 441 ■ Brass, nickel-plated ■ Authorised cable diameter: 6 ... 12 mm ■ Tightening torque 8 Nm 	 <ul style="list-style-type: none"> ■ M20 x 1.5 cable gland, plastic ■ For TQ 700 ■ Polyamide ■ Authorised cable diameter: 6 ... 12 mm ■ Tightening torque 4.5 Nm 	 <ul style="list-style-type: none"> ■ M20 x 1.5 screw plug, metal ■ For TQ 900 / TQ 441 ■ Brass, nickel-plated ■ Tightening torque 8 Nm 	
Indicator lamp G24-M20	Pull wire with sphere - PR-B...		
 <ul style="list-style-type: none"> ■ Indicator lamp G24-M20 for TQ 900 (LED 24 VDC – red/green) 	 <ul style="list-style-type: none"> ■ Pull wire with sphere for TQ 700 S ■ PR-B-1M 101218018 ■ PR-B-2M 101218019 ■ PR-B-3M 101218020 ■ PR-B-4M 101218021 		

For detailed information on selection, visit www.schmersal.net.

Up-to-date without fail
Online on the world wide web

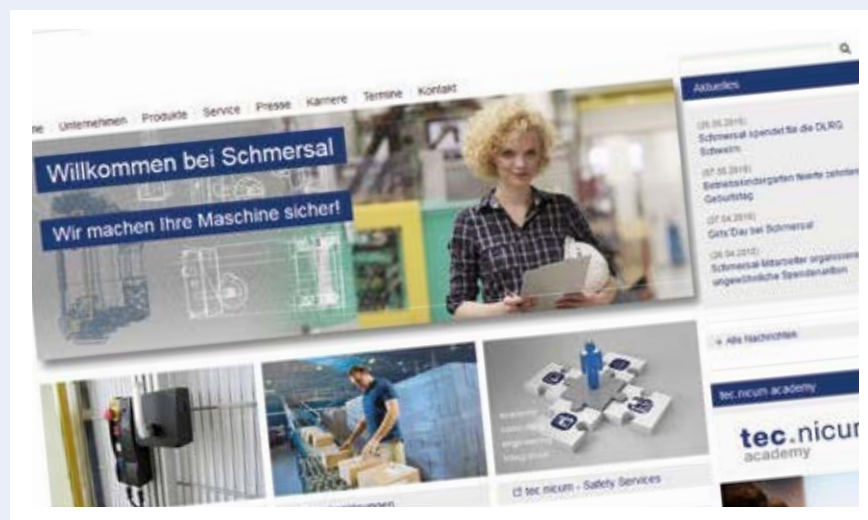

For detailed information, check out
www.schmersal.com

7. Foot switches

Description

Area of application

Safety foot switches are mounted on machines and plants in cases where manual operation is not possible. They are used to initiate and shutdown work and production cycles.

Depending on the ambient conditions and mechanical load, there are different foot switch variants. The robust foot switches in a metal design are used generally in machine tools and plants, e.g. on presses, punches, bending and sheet metal machinery etc.

The plastic foot switches of the NKF series are used as signal generators for switching on and off process and production sequences. They are used in all industrial environments such as in the textile industry, logistics and material handling and also in the packaging industry.

Design and way of functioning

All foot switches in the range TF 232 are available both with protective cover (ordering suffix H) and without. The devices equipped with either slow action or snap action switch inserts are available as both single-pedal and double-pedal variants. Up to 4 contacts are available per pedal.

The additional contact staggering and bi-stable operating principles expand the wide range of possible uses.

The plastic foot switches in the range NKF offer solutions for up to three pedals with either NO contacts or change-over contacts. The pre-assembled variants are equipped as standard with a 2 meter pre-wired cable.



Staggered operating principle (ordering suffix -HD)

The staggering is realised by means of a pressure point, which is installed under the pedal. When the foot pedal is actuated as far as the pressure point, 1 NO contact is closed. If the pedal is actuated beyond the pressure point, the second NO contact is closed. The first pair of contacts remain enabled.

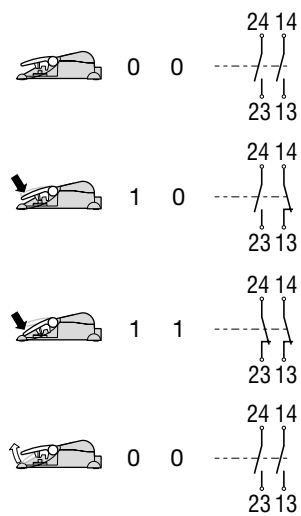

Bi-stable operating principle (ordering suffix -F)

Upon the first foot lever action, the switch insert is switched on (= ON). Upon the second foot lever action, the latching of the switching elements is neutralised, i.e. the switch insert is switched off by the spring in the switch insert (= OFF) (push/push function).

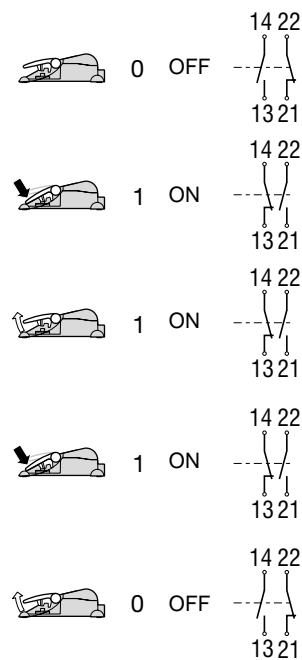

7. Foot switches

Overview of the series



■ F 232



■ 2F 232



■ NK F

Key Features

- | | | |
|---|---|--|
| <ul style="list-style-type: none"> • With 1 foot pedal • 2 or 4 contacts • Enclosure in Aluminium die-cast | <ul style="list-style-type: none"> • With 2 foot pedals • 4, 6 or 8 contacts • Enclosure in Aluminium die-cast | <ul style="list-style-type: none"> • 1, 2- or 3 foot pedals • max. 2 contacts per pedal • Plastic enclosure |
|---|---|--|

Other versions

Staggered contacts	■	■	–
Bi-stable function	■	–	–

Technical features

Electrical characteristics			
Max. switching capacity U/I	230 VAC / 4 A; 24 VDC / 1 A	230 VAC / 4 A; 24 VDC / 1 A	240 VAC / 2.5 A; 24 VDC / 1 A
Mechanical data			
Execution of the electrical connection	Screw terminals	Screw terminals	connecting cable
Cable entry	1 x M20	2 x M25	–
Cable section ¹⁾	0.75 ... 2.5 mm ²	0.75 ... 2.5 mm ²	0.5 mm ²
Dimensions (H x W x D)	170 x 189 x 274 mm	295 x 189 x 274 mm	depending on the version
Ambient conditions			
Ambient temperature	–25 °C ... +60 °C	–25 °C ... +60 °C	–25 °C ... +60 °C
Protection class	IP65	IP65	IP67

Safety classification

Standards	IEC/EN 60947-5-1	IEC/EN 60947-5-1	IEC/EN 60947-5-1
B _{10D} NC contact	100,000	100,000	100,000
Certificates			

¹⁾ Including conductor ferrules



To get detailed information about the products and certificates, visit www.schmersal.net.

7. Foot switches

Ordering details



Series	Protective cover	Pedals	Switching principle	Contacts / pedal	Special features	Type designation	Material number				
T/Z.. 232	TF 232	with 1 foot pedal	Slow action	1 NO/1 NC		TF 232-11	101181519				
				1 NO/1 NC	Bi-stable function	TF 232-11F	101182012				
				2 NO/2 NC		TF 232-22	101181525				
	1 NO/1 NC				TFH 232-11	101181529					
	1 NO/1 NC			Bi-stable function	TFH 232-11F	101182016					
	2 NO/2 NC				TFH 232-22	101181532					
	TFH 232	■	with 1 foot pedal	Slow action	2NO	Staggered contacts	TFH 232-20HD	101182013			
					1 NO/1 NC		ZF 232-11	101181537			
	2 NO/2 NC				ZF 232-22	101181539					
	ZF 232	■			with 1 foot pedal	Snap action	1 NO/1 NC		ZFH 232-11	101181541	
							2 NO/2 NC		ZFH 232-22	101181543	
	ZFH 232	■					with 2 foot pedals	Slow action	1 NO/1 NC		T2F 232-11/11
			1 NO/1 NC						T2FH 232-11/11	101181584	
	T2F 232	■	with 2 foot pedals	Snap action					2 NO/2 NC		T2FH 232-22/22
1 NO/1 NC										Z2F 232-11/11	101181590
T2FH 232	■	with 2 foot pedals			Snap action	1 NO/1 NC				Z2FH 232-11/11	101181594
						2 NO/2 NC				Z2FH 232-22/22	101181596
NKF	NKF					with 1 foot pedal	Snap action	1 change-over contact		NKF1-1PWZ-B-2M	103003074
								1NO		NKF1-10Z-B-2M	103003077
	NKF2		with 2 foot pedals	Snap action		1 change-over contact			NKF2-1PW/1PWZ-B-2M	103003075	
						1NO			NKF2-10/10Z-B-2M	103003078	

Other versions upon request

Appendix

Product index – alphabetical

Series	Page	Series	Page	Series	Page
ACC-700-RZ173I	129	Egg-shaped wire clamp	129	T/M 015	34
Actuating magnets	120	Eyebolt	129	T/M 017	35
BE 20 24V	123	F 232	134	T/M 035	36
Belt alignment lever	83	G150	80	T/M 064	37
BN 120	115	G24-M20	130	T/M 250	37
BN 20	115	G50	80	T/M 250 Belt alignment switch	81
BN 310	114	H 15	123	T/M 441	35
BN 325	115	H1/1	123	T/M 441 Belt alignment switch	81
BN 650	115	H2	123	T/M 441 Slack-wire switch	80
BN 75	115	HOLDER H1/1	123	T/M 461	35
BN 80	114	HOLDER H2	123	T/M 471	37
BN 85	114	Indicator lamp G24-M20	130	T2F 232	134
BP 10	120	M 330	34	T2FH 232	134
BP 11 N	120	M 330 Belt alignment switch	81	Tension spring	129
BP 11 S	120	M 610	88	Tension spring	129
BP 12 N	120	M 630	88	Tensioner	129
BP 12 S	120	M 660 / 6600	89	TF 232	134
BP 15 SS	120	M 6610 / 6620	89	TFH 232	134
BP 15 SS	121	M 6800 / 6900	88	TQ 441	127
BP 15/2	121	M 687	89	TQ 700	126
BP 20	121	M/T 697	89	TQ 700 S	126
BP 20 N	121	MSP 452	80	TQ 900	127
BP 20 S	121	NKF	134	U 432	36
BP 21 N	121	NKF	134	U 434	36
BP 21 S	121	NKF2	134	Wire clamp	129
BP 22 N(S)	122	Pointed cam with front setting	82	Wire rope	130
BP 22/2 N(S)	122	PR-B-..	130	Wire rope	130
BP 31	122	PS116	16	Wire rope with ball	130
BP 31 N	122	PS215	16	Wire rope with ball	130
BP 31 N	122	PS216	16	Wire thimbles	129
BP 310-1 N	122	PS226	17	Wire unit complete	130
BP 310-1 S	122	PS315	17	Z/T 232	89
BP 310-2 N	122	PS316	17	Z/T 6881	89
BP 310-2 S	122	Pulley	129	Z/T 6881	89
BP 34	121	RF-454-DN	83	Z2F 232	134
BP 34/2	121	RZ-2041	129	Z2F 232	134
BP 6	120	S 900	130	Z2FH 232	134
BP 7	120	S 900 wire tensioner	130	Z2FH 232	134
BP 8	120	Shackle	129	ZF 232	134
CLAMP H 15	123	T 016	34	ZF 232	134
COMPENSATION COIL KS 1	123	T 130/136	37	ZFH 232	134
COMPENSATION COIL KS 2	123	T 422	35	ZFH 232	134
Duplex wire clamp	129	T 454	35		
Dupline interface RF-454-DN	83	T. 454 Belt alignment switch	81		

tec.nicum

Your partner for machine safety and workplace protection

tec.nicum is the new service division of the Schmersal Group. It offers machine manufacturers, machine operators and distributors competent advice with product and manufacturer neutrality.

tec.nicum supports its clients in the reliable design of machines and workplaces. The tec.nicum team drafts and realises safety solutions across all lifecycle stages of the machine.

The new range of services:



tec.nicum academy
Seminars and training



tec.nicum consulting
Consultancy services



tec.nicum engineering
Design, planning and
PLC programming



tec.nicum integration
Execution and installation



For detailed information, check out
www.tecnicum.com

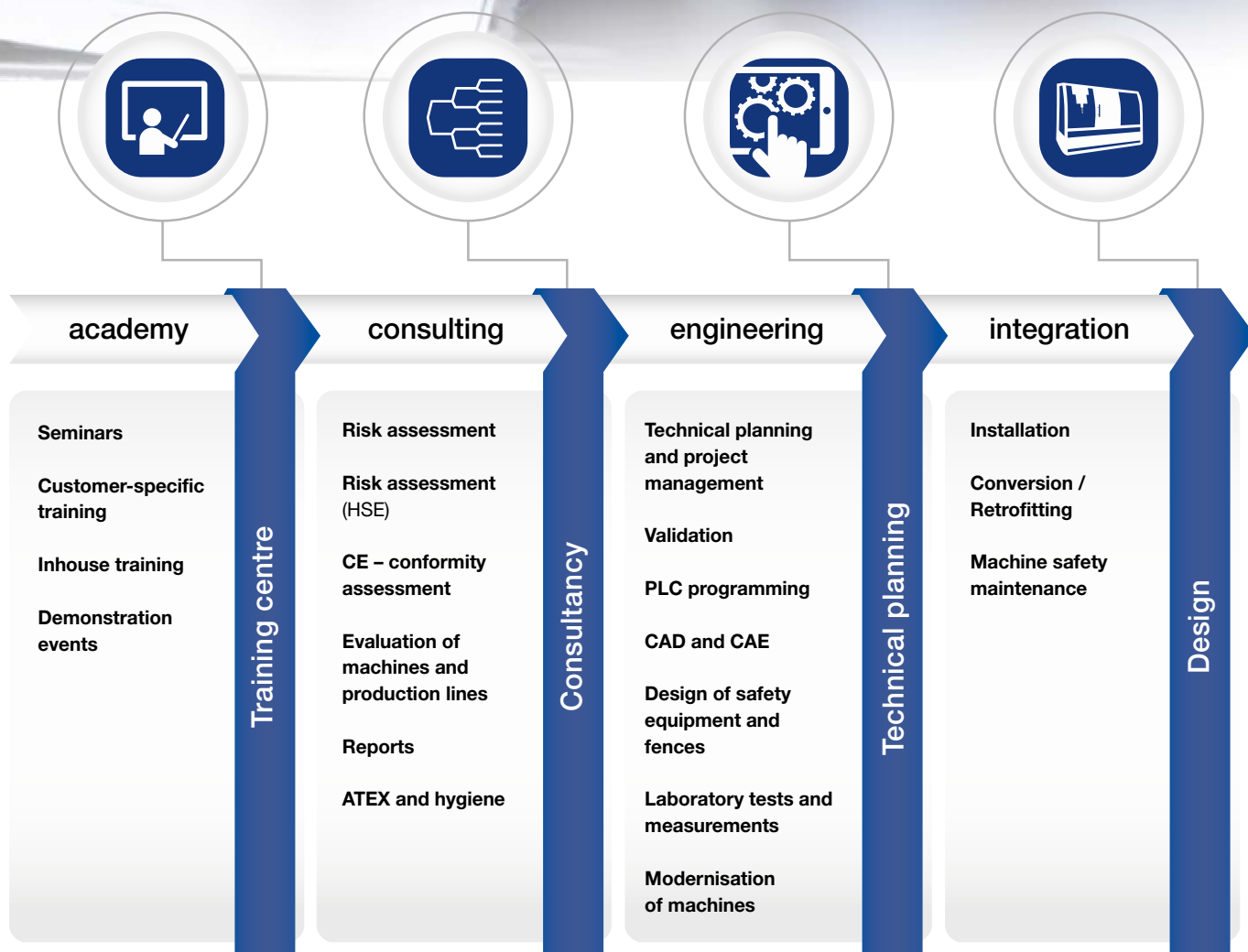

The range at tec.nicum covers four columns: learning in the **academy section**, consultancy services in the **consultancy section**, designing safety solutions in the **engineering section** and practical implementation in the **integration section**.

The head office of the tec.nicum organisation, which operates all over the world, is in Wuppertal, Germany.

Contact:

tec.nicum

K.A. Schmersal GmbH & Co. KG
 Möddinghofe 30
 42279 Wuppertal
 Phone: +49 202 6474-932
 Telefax: +49 202 6474-100
 E-Mail: info-de@tecnicum.com
 www.tecnicum.com



Addresses

■ **Hauptsitz – Headquarters**
K.A. Schmersal GmbH & Co. KG
Postfach 24 02 63,
42232 Wuppertal
Möddinghofe 30
42279 Wuppertal
Phone: +49 202 6474-0
Fax: +49 202 6474-100
info@schmersal.com
www.schmersal.com

Germany

■ **Leipzig**
K.A. Schmersal GmbH & Co. KG
Vertriebsbüro Leipzig
Servicepark
Druckereistraße 4
04159 Leipzig
Phone: +49 341 48734-50
Fax: +49 341 48734-51
vbleipzig@schmersal.com

■ **Berlin**
**KSA Komponenten der Steuerungs-
und Automatisierungstechnik GmbH**
Pankstraße 8-10 / Aufg. L
13127 Berlin
Phone: +49 30 474824-00
Fax: +49 30 474824-05
info@ksa-gmbh.de
www.ksa-gmbh.de

■ **Hamburg / Münster**
K.A. Schmersal GmbH & Co. KG
Vertriebsbüro Hamburg
Innungsstraße 3
21244 Buchholz i.d.N.
Phone: +49 41 81 9220-0
Fax: +49 41 81 9220-20
vbhamburg@schmersal.com

■ **Hannover**
ELTOP GmbH
Robert-Bosch-Straße 8
30989 Gehrden
Phone: +49 51 089273-20
Fax: +49 51 089273-21
eltop@eltop.de
www.eltop.de

■ **Wettenberg**
K.A. Schmersal GmbH & Co. KG
Vertriebsbüro Wettenberg
Im Ostpark 2
35435 Wettenberg
Phone: +49 641 9848-575
Fax: +49 641 9848-577
vbwettenberg@schmersal.com

■ **Köln**
Stollenwerk
Technisches Büro GmbH
Scheuermühlenstraße 40
51147 Köln
Phone: +49 2203 96620-0
Fax: +49 2203 96620-30
info@stollenwerk.de
www.stollenwerk.de

■ **Siegen**
Siegfried Klein
Elektro-Industrie-Vertretungen
In der Steinwiese 46
57074 Siegen
Phone: +49 271 6778
Fax: +49 271 6770
info@sk-elektrotechnik.de
www.sk-elektrotechnik.de

■ **Saarland**
**Herbert Neundörfer Werks-
vertretungen GmbH & Co. KG**
Am Campus 5
66287 Göttelborn
Phone: +49 6825 9545-0
Fax: +49 6825 9545-99
info@herbert-neundoerfer.de
www.herbert-neundoerfer.de

■ **Bietigheim**
K.A. Schmersal GmbH & Co. KG
Technologiezentrum
Pleidelsheimer Straße 15
74321 Bietigheim-Bissingen
Phone: +49 7142 91028-0
Fax: +49 7142 91028-28
tzbw@schmersal.com

■ **Bayern Süd**
INGAM Ing. Adolf Müller GmbH
Industrievertretungen
Elly-Staegmeyer-Straße 15
80999 München
Phone: +49 89 8126044
Fax: +49 89 8126925
info@ingam.de
www.ingam.de

■ **Nürnberg**
K.A. Schmersal GmbH & Co. KG
Vertriebsbüro Nürnberg
Lechstraße 21
90451 Nürnberg
Phone: +49 911 6496053
Fax: +49 911 63290729
vbnuernberg@schmersal.com

Europe

■ **Austria – Österreich**
AVS-Schmersal Vertriebs Ges.m.b.H.
Biróstraße 17
1232 Wien
Phone: +43-1-6 10 28
Fax: +43-1-6 10 28-1 30
info@avs-schmersal.at
www.avs-schmersal.at

■ **Belgium – Belgien**
Schmersal Belgium NV/SA
Nieuwlandlaan 73
Industriezone B413
3200 Aarschot
Phone: +32-16-57 16 18
Fax: +32-16-57 16 20
info@schmersal.be
www.schmersal.be

■ **Bosnia and Herzegovina**
Tipteh d.o.o. Sarajevo
Ulica Ramiza Salčina 246
71000 Sarajevo
Phone: +387-61 92 36 23
nadir.durmic@tipteh.ba
www.tipteh.ba

■ **Bulgaria – Bulgarien**
CDL Sensorik Ltd.
Chavdar Voivoda Str, No.12, Office 1
7002 Ruse City
Phone: +359 82 82 00 52
office@cdlsensorik.com
www.cdlsensorik.com

■ **Croatia – Kroatien**
Tipteh Zagreb d.o.o.
Ratarska 35
10000 Zagreb
Phone: +385 1-3 81 65 74
Fax: +385 1-3 81 65 77
tipteh@tipteh.hr
www.tipteh.hr

■ **Czech Republic – Tschech. Republik**
MERCOM COMPONENTA s.r.o.
Bechyňská 640
199 00 Praha 9 – Letňany
Phone: +4 20-267 31 46 40-2
mercom@mercom.cz
www.mercom.cz
www.schmersal.cz

■ **Denmark – Dänemark**
Schmersal Danmark A/S
Lautruphøj 1-3
2750 Ballerup
Phone: +45-70 20 90 27
Fax: +45-70 20 90 37
info@schmersal.dk
www.schmersal.dk

■ **Finland – Finnland**
Advancetec Oy
Äyritie 12 B
01510 Vantaa
Phone: +3 58-2 07 19 94 30
Fax: +3 58-9 35 05 26 60
advancetec@advancetec.fi
www.schmersal.fi

■ **France – Frankreich**
Schmersal France
BP 18 – 38181 Seyssins Cedex
8, rue Raoul Follereau
38180 Seyssins
Phone: +33-4 76 84 23 20
technique@schmersal.com
info-fr@schmersal.com
www.schmersal.fr

■ **Greece – Griechenland**
Kalamarakis Sapounas S.A.
Ionias & Neromilou
PO Box 46566 Athens
13671 Chamomilos Acharnes
Athens
Phone: +30-210-2 40 60 00-6
Fax: +30-210-2 40 60 07
ksa@ksa.gr
www.ksa.gr

■ **Hungary – Ungarn**
NTK Ipari-Elektronikai és
Kereskedelmi Kft
Gesztenyefa u. 4.
9027 Győr
Phone: +36-96-52 32 68
Fax: +36-96-43 00 11
info@ntk-kft.hu
www.ntk-kft.hu

■ **Iceland – Island**
Reykjafell Ltd.
Skipholt 35
125 Reykjavik
Phone: +354-5 88 60 10
Fax: +354-5 88 60 88
reykjafell@reykjafell.is

■ **Italy – Italien**
Schmersal Italia s.r.l.
Via Molino Vecchio, 206
25010 Borgosatollo, Brescia
Phone: +39-0 30-2 50 74 11
Fax: +39-0 30-2 50 74 31
info@schmersal.it
www.schmersal.it

■ **Lithuania/Estonia/Latvia -
Litauen/Estland/Lettland**
BOPLALIT
Mus galite rasti:
Baltų pr. 145, LT-47125, Kaunas
Phone: +370 37 298989
Phone: +370 37 406718
info@boplalit.lt
www.boplalit.lt

■ **Macedonia – Mazedonien**
Tipteh d.o.o. Skopje
Bul Partizanski odredi br:80, Lok:5
1000 Skopje
Phone: +389-70-39 94 74
Fax: +389-23-17 41 97
info@tipteh.mk
www.tipteh.mk

■ **Netherlands – Niederlande**
Schmersal Nederland B.V.
Lorentzstraat 31
3846 AV Harderwijk
Phone: +31-3 41-43 25 25
Fax: +31-3 41-42 52 57
info-nl@schmersal.com
www.schmersal.nl

■ **Norway – Norwegen**
Schmersal Norge
Hoffsveien 92
0377 Oslo
Phone: +47-22 06 00 70
Fax: +47-22 06 00 80
info-no@schmersal.com
www.schmersal.no

■ **Poland – Polen**
Schmersal - Polska Sp.j.
ul. Baletowa 29
02-867 Warszawa
Phone: +48-22-8 16 85 78
Fax: +48-22-8 16 85 80
info@schmersal.pl
www.schmersal.pl

■ **Portugal – Portugal**
Schmersal Ibérica, S.L.
Apartado 30
2626-909 Póvoa de Sta. Iria
Phone: +351-219 593 835
info-pt@schmersal.com
www.schmersal.pt

■ **Romania – Rumänien**
CD SENSORIC SRL
Str. George Enescu 21
550248 Sibiu
Phone: +40-2 69-25 33 33
Fax: +40-2 69-25 33 44
proiecte@cdl.ro
www.cdl.ro

■ **Russia – Russland**
OOO AT electro Moskau
ul. Avtosavodskaya 16-2
109280 Moskau
Phone: +7-49 5-9 21 44 25
Fax: +7-49 5-9 26 46 45
info@at-e.ru
www.at-e.ru

OOO AT electro Petersburg
Polytechniskaya str, d.9,B
194021 St. Petersburg
Phone: +7-81 2-7 03 08 17
Fax: +7-81 2-7 03 08 34
spb@at-e.ru

AT-Electronics Ekaterinburg
Bebelya str. 17, room 405
620034 Ekaterinburg
Phone: +7-34 3-2 45 22 24
Fax: +7-34 3-2 45 98 22
ural@at-e.ru

■ **Serbia – Serbien**
Tipteh d.o.o. Beograd
Moše Pijade 17A
11070 Vrčin, Belgrade
Phone: +3 81 (0)11 – 8053 628
Fax: +3 81 (0)11 – 8053 045
office@tipteh.rs
www.tipteh.rs

■ **Slovakia – Slowakei**
MERCOM COMPONENTA s.r.o.
Bechyňská 640
199 00 Praha 9 – Letňany
Phone: +4 20-267 31 46 40-2
mercom@mercom.cz
www.mercom.cz
www.schmersal.cz

■ **Slovenia – Slowenien**
Tipteh d.o.o.
Ulica Ivana Roba 21
1000 Ljubljana
Phone: +386-1-2 00 51 50
Fax: +386-1-2 00 51 51
info@tipteh.si
www.tipteh.si

■ **Spain – Spanien**
Schmersal Ibérica, S.L.
Rambla P. Catalanes, 12
08800 Vilanova i la Geltrú
Phone: +34-902 56 64 57
info-es@schmersal.com
www.schmersal.es

■ **Sweden – Schweden**
Schmersal Nordiska AB
F O Petersons gata 28
421 31 Västra Frölunda
Phone: +46-31-3 38 35 00
Fax: +46-31-3 38 35 39
info-se@schmersal.com
www.schmersal.se

Addresses

- **Switzerland – Schweiz**
Schmersal Schweiz AG
 Moosmattstraße 3
 8905 Arni
 Phone: +41-43-3 11 22 33
 Fax: +41-43-3 11 22 44
 info-ch@schmersal.com
 www.schmersal.ch
- **Turkey – Türkei**
Entek Otomasyon Urunleri San. ve Tic. A.S.
 Mahmutbey Mah.
 Tasocagi Yolu Cad. No: 9 Entek Plaza
 34218 Bagcilar / Istanbul
 Phone: +90 850 201 4141
 Fax: +90 212 320 1188
 info@entek.com.tr
 www.entek.com.tr
- **Ukraine – Ukraine**
VBR Ltd.
 41, Demiyivska Str.
 03040 Kyiv Ukraine
 Phone: +38 (044) 259 09 55
 Fax: +38 (044) 259 09 55
 office@vbr.com.ua
 www.vbr-electric.com.ua/schmersal
- **United Kingdom – Großbritannien**
Schmersal Ltd.
 Sparrowhawk Close
 Enigma Business Park
 Malvern Worcestershire WR14 1GL
 Phone: +44-16 84-57 19 80
 Fax: +44-16 84-56 02 73
 uksupport@schmersal.com
 www.schmersal.co.uk
- **Canada – Kanada**
Schmersal Canada LTD.
 15 Regan Road Unit #3
 Brampton, Ontario L7A 1E3
 Phone: +1 905 495-7540
 Fax: +1 905 495-7543
 Info-ca@schmersal.com
 www.schmersal.ca
- **Chile – Chile**
Vitel S.A.
 francisco@vitel.cl
 www.vitel.cl
SOLTEX
 central@soltext.cl
 www.soltext.com.cl
INSTRUTEC
 gcaceres@instrutec.cl
 www.instrutec.cl
OEG
 jmp@oegggroup.com
 www.oegggroup.cl
ECOL INDUSTRIAL ELECTRIC
 ventas@eocol.cl
 www.eocol.cl
- **PR China – VR China**
Schmersal Industrial Switchgear (Shanghai) Co. Ltd.
 Cao Ying Road 3336
 201712 Shanghai / Qingpu
 Phone: +86-21-63 75 82 87
 Fax: +86-21-63 75 82 97
 sales@schmersal.com.cn
 www.schmersal.com.cn
- **Colombia – Kolumbien**
EQUIPELCO
 aospina@equipelco.com
 www.equipelco.com
SAMCO
 jvargas@samcoingenieria.com
 www.samcoingenieria.com
- **Ecuador – Ecuador**
SENORTEC S.A
 AV. Napo y Pinto Guzmán
 Quito
 Phone: +593 091 40 27 65
 +593 095 04 86 11
 infogy@sensortecsa.com
 www.sensortecsa.com
- **Guatemala – Guatemala**
PRESTELECTRO
 AV Petapa 44-22,
 Zona 12; Cent. Com Florencia 01012
 Phone: +502 24 42-33 46
 Anabella.Barrios@prestelectro.com
 www.prestelectro.com
- **India – Indien**
Schmersal India Private Limited
 Plot No G 7/1,
 Ranjangaon MIDC,
 Taluka Shirur,
 District Pune 412220, India
 Phone: +91 21 38 61 47 00
 Fax: +91 20 66 86 11 14
 info-in@schmersal.com
 www.schmersal.in
- **Indonesia – Indonesien**
PT. Wiguna Sarana Sejahtera
 Jl. Daan Mogot Raya No. 47
 Jakarta Barat 11470
 Phone: +62-21-5 63 77 70-2
 Fax: +62-21-5 66 69 79
 email@ptwiguna.com
 www.ptwiguna.com
- **Iran – Iran**
Omid Electric
 No. 1-5, 1st Floor, Azizi passage,
 Southern Lalehzar Str. Tehran
 ZIP: 1144944181
 Phone: +98 21 33924027
 +98 21 33911022
 Fax: +98 21 33936635
 sales@omidelectric.com
 www.omidelectric.com
- **Israel – Israel**
A.U. Shay Ltd.
 23 Imber St. Kiriat. ArieH.
 P.O. Box 10049
 Petach Tikva 49222 Israel
 Phone: +9 72-3-9 23 36 01
 Fax: +9 72-3-9 23 46 01
 shay@uriel-shay.com
 www.uriel-shay.com
- **Japan – Japan**
Schmersal Japan KK
 3-39-8 Shoa, Suginami-ku
 Tokyo 167-0054
 Phone: +81-3-3247-0519
 Fax: +81-3-3247-0537
 safety@schmersaljp.com
 www.schmersal.jp
- **Korea – Korea**
Mahani Electric Co. Ltd.
 20, Gungmal-ro, Gwacheon-si,
 Gyeonggi-do 427-060, Korea
 Phone: +82-2-21 94-33 00
 Fax: +82-2-21 94-33 97
 yskim@mec.co.kr
 www.mec.co.kr
- **Malaysia – Malaysien**
Ingermark (M) SDN.BHD
 No. 29, Jalan KPK 1/8
 Kawasan Perindustrian Kundang
 48020 Rawang, Selangor Darul Ehsan
 Phone: +6 03-60-34 27 88
 Fax: +6 03-60-34 21 88
 enquiry@ingermark.com
- **Mexico – Mexiko**
ISEL SA de CV
 mario.c@isel.mx
 www.isel.com.mx
INNOVATIVE AUTOMOTION SOLUTIONS
 ias@iasmx.com
 www.iasautomation.com.mx
EASA ENERGIA Y AUTOMATIZACIÓN
 ias@iasmx.com
 www.iasautomation.com.mx
DINAMICA S.A de C.V
 ias@iasmx.com
 www.iasautomation.com.mx
SIGRAMA S.A de C.V
 ias@iasmx.com
 www.iasautomation.com.mx
VGR TECHNOLOGIES
 ias@iasmx.com
 www.iasautomation.com.mx
- **New Zealand – Neuseeland**
Hamer Automation
 85A Falsgrave Street
 Philipstown
 Christchurch, New Zealand
 Phone: +64-33 66 24 83
 Fax: +64-33 79 13 79
 sales@hamer.co.nz
 www.hamer.co.nz
- **Pakistan – Pakistan**
Schmersal India Private Limited
 Plot No G 7/1,
 Ranjangaon MIDC,
 Taluka Shirur,
 District Pune 412220, India
 Phone: +91 21 38 61 47 00
 Fax: +91 20 66 86 11 14
 info-in@schmersal.com
 www.schmersal.in
- **Paraguay – Paraguay**
Brasguay S.R.L.
 R. Internacional 07
 KM 14 ; Minga Guazu
 Phone: +595 (61) 583-418 218 577
 brasguay@brasguay.com.py
 www.brasguay.com.py
- **Peru – Peru**
Fametal S.A.
 fametal@fametal.com
 www.fametal.com
AYD
 informes@ayd.com.pe
 www.ayd.com.pe
- **Singapore – Singapur**
AZAREL International Pte Ltd.
 Empire Techno Centre
 30 Kaki Bukit Road 3 #01-10
 Singapore 417819
 Phone: +65-67 42 29 88
 Fax: +65-67 42 26 28
 sales@azarel.com.sg
 www.azarel.com.sg
- **South Africa – Südafrika**
A+A Dynamic Distributors (Pty) Ltd.
 20-24 Augusta Road
 Regents Park
 2197 Booyens
 Phone: +27-11-6 81 59 00
 Fax: +27-11-4 35 13 18
 awkayser@iafrika.com
- **Taiwan – Taiwan**
Golden Leader Camel Ent. Co., Ltd.
 No. 453-7, Pei Tun Rd.
 Taichung City 40648, Taiwan
 Phone: +886-4-22 41 29 89
 Fax: +886-4-22 41 29 23
 camel88@ms46.hinet.net
 www.leadercamel.com.tw
- **Thailand – Thailand**
Isensor Co. Ltd.
 57/65 Soi Song Sa-ard
 Vibhavadirangsit Road
 Chomphon, Chatuchak
 Bangkok 10900
 Phone: +66 - 2 - 276 8783
 Fax: +66 - 2 - 275 5875
 info@isensor.co.th
 www.isensor.co.th
- **United Arab Emirates – Vereinigte Arabische Emirate**
Kempston Controls LLC
 PO Box: 60998
 St. 13, Umm Ramool,
 Dubai, U.A.E.
 Tel: +971 4 2987 111
 Fax: +971 4 2987 113
 Email: sales@kempstoncontrols.ae
 www.kempstoncontrols.ae
- **Uruguay – Uruguay**
Gliston S.A.
 Pedernal 1896 – Of. 203
 Montevideo
 Phone: +598 (2) 2 00 07 91
 colmedo@gliston.com.uy
 www.gliston.com.uy
- **USA – USA**
Schmersal Inc.
 15 Skyline Drive
 Hawthorne, NY 10532
 Phone: +1 8 88-4 96-51 43
 Fax: +1 9 14-3 47-15 67
 infousa@schmersal.com
 www.schmersalusa.com
- **Venezuela – Venezuela**
EMI Equipos y Sistemas C.A.
 Calle 10, Edf. Centro Industrial
 Martinisi, Piso 3, La Urbina, Caracas
 Phone: +58 (212) 2 43 50 72
 ventas@emi-ve.com
 www.emi-ve.com
- **Vietnam – Vietnam**
Ingermark (M) Sdn Bhd, Rep Office
 Unit 208, C6 Bldg., Block 1
 My Dinh 1, New Urban Area
 Tu Liem District, Hanoi
 Phone: +84-4 287 2638
 Fax: +84-4 287 2639
 ingvietn18@yemail.com

Worldwide



The Schmersal Group

In the demanding field of machine safety, the owner-managed Schmersal Group is one of the international market leaders. The company, which was founded in 1945, has a workforce of about 2000 people and seven manufacturing sites on three continents along with its own companies and sales partners in more than 60 nations.

Customers of the Schmersal Group include global players from the area of mechanical engineering and plant manufacturing as well as operators of machinery. They profit from the company's extensive expertise as a provider of systems and solutions for machine safety. Furthermore, Schmersal specialises in various areas including foodstuff production, the packaging industry, machine tool industry, lift switchgear, heavy industry and the automotive industry.

A major contribution to the systems and solutions offered by the Schmersal Group is made by tec.nicum with its comprehensive range of services: certified Functional Safety Engineers advise machinery manufacturers and machinery operators in all aspects relating to machinery and occupational safety – and do so with product and manufacturer neutrality. Furthermore, they plan and realise complex solutions for safety around the world in close collaboration with the clients.

Safety Products



- Safety switches and sensors, solenoid interlocks
- Safety controllers and safety relay modules, safety bus systems
- Optoelectronic and tactile safety devices
- Automation technology: position switches, proximity switches

Safety Systems



- Complete solutions for safeguarding hazard areas
- Individual parametrisation and programming of safety controllers
- Tailor-made safety technology – be it for individual machines or a complex production line
- Industry-specific safety solutions

Safety Services



- tec.nicum academy – Seminars and training
- tec.nicum consulting – Consultancy services
- tec.nicum engineering – Design and technical planning
- tec.nicum integration – Execution and installation

The details and data referred to have been carefully checked.
Subject to technical amendments and errors.

www.schmersal.com



x.000 / L+W / 06.2018 / Material-Nr. 103013940 / EN / Ausgabe 01

 **SCHMERSAL**
Safe solutions for your industry